



ADDENDUM NO.: 1

IFB or RFP NO.: 742

Description: Furnish, Deliver and Install AV Equipment

Project: SUNY Fashion Institute of Technology

Bid Opening Date: Friday, February 17, 2023, at 3:00PM

Specifics of the Addendum: Addition of Aurora equipment to the bid package.

Please see attached updated specifications and drawings with the addition of Aurora equipment.

All other terms and conditions of the original Invitation for Bids shall remain the same.

FIT NAB		SMW Project 16202
AV SYSTEMS PROCUREMENT - ADDENDUM 1		
ITEM	SYSTEM NAME	ROOM #'s
1	Knitting Lab	NC10
3	Stoll Computer Lab	NC12
4	High Tech Meeting Room	N108
5	Workshop Classrooms	N208, N308, N408, N708, N808
6	Classrooms	N204, N206, N207, N304, N305, N306, N307, N404, N405, N406, N407, N704, N705, N706, N707, N804, N805, N806, N807
7	Large Conference Room	N908
8	Presidents Office	N900
9	Student Life Hall	N503
10	PAGING	

FIT NAB								
Knitting Lab			Room Numbers			NC10		
AV SYSTEMS PROCUREMENT								
SYSTEM ID	DESCRIPTION	DRAWING ID	CONSTRUCTION SEQUENCE	FURNISHED BY	MFR	MODEL	NOTES	QTY
DISPLAY								
PRJ01	Video Projector 6500 Lumens 4K With lens	V291	*	AV contractor	NEC	NP-PA653U-41ZL		1
	Universal RPA Ceiling Projector Mount		Device installation requires coordination with project General Contractor	AV contractor	Chief	RPAU		1
FPD20	Flatpanel Display - 27" Touch Enabled Desktop		-	AV contractor	Planar	Helium PCT2785		1
AUDIO								
DSP04	Audio DSP - 12 Input, 8 Output, AEC, DANTE, USB		-	AV contractor	BiAmp	TesiraFORTE DAN CI		1
AMP02	Audio Amplifier - 1ch. 120wpc 70V		-	AV contractor	Labgruppen	LUCIA 120/1-70		1
SPK30	Loudspeaker - Ceiling Recessed 6"	V240	Device installation requires coordination with project General Contractor	AV contractor	Tannoy	CMS 603DC BM		6
DAN02	Netork interface - 2x2 DANTE		-	AV contractor	Shure	ANI22-BLOCK		1
MIC40	Gooseneck Microphone 18"	V185	-	AV contractor	Shure	MX418/C		1
WMS02	Wireless Mic - Lavalier Omni/Bodypack/RX		-	AV contractor	Shure	QLXD 14/93		1
VIDEO								
CODEC1	Video Codec - Room kit Plus PTZ 4k.	V170 & V156	-	AV contractor	Cisco	CS-KITPLPTZ4K-K9	Codec, PTZ Camera & Touch panel	1
DOCM1	Document Camera, 4K	V179	-	AV contractor	Wolfvisions	VZ8-UHD		1
AVB01	USB CAPTURE HSMI Plus		-	AV contractor	Magewell	32040		1
MTX01	Video Matrix Switcher - 4x2 4K		-	AV contractor	Lightware	MMX4x2-HDMI-USB20L	HDMI & USB switching	1
CAMEX	Camera Extender - Camera extension Kit		-	AV contractor	Sound Control Technologies	RC5-CW4		1
HDTX1	HDBT Transmitter - HDMI		-	AV contractor	Lightware	HDMI-TPS-TX86		4
HDTX2	HDBT Transmitter - HDMI		-	AV contractor	Lightware	HDMI-TPS-TX210		1
HDRX1	HDBT Receiver - HDMI		-	AV contractor	Lightware	HDMI-TPS-RX86		2
CONTROL								
MISC.								
OFE01	Host PC, Keyboard & Mouse		-	Owner Furnished Contractor Installed	OFE	OFE		1
AVS01	Data Switch - 24 port, 1g PoE+, 1000w PSU		-		Netgear	GSM4328PB-100NES		1
ERK02	Equipment Rack - 45RU, Pre-Configured for Pro Av		-		Middle Atlantic	BGR-4527-AV	Located in V108B	1
CCH01	Misc. Wire, Cables, Plates/Panels & Connectors		-		Custom	By AV Contractor		1

FIT NAB								
Stoll Computer Lab				Room Numbers		NC12		
AV SYSTEMS PROCUREMENT								
SYSTEM ID	DESCRIPTION	DRAWING ID	CONSTRUCTION SEQUENCE	FURNISHED BY	MFR	MODEL	NOTES	QTY
DISPLAY								
PRJ01	Video Projector 6500 Lumens 4K With lens	V291	-	AV contractor	NEC	NP-PA653U-41ZL		2
	Universal RPA Ceiling Projector Mount		Device installation requires coordination with project General Contractor	AV contractor	Chief	RPAU		1
FPD20	Flatpanel Display - 27" Touch Enabled Desktop		-	AV contractor	Planar	Helium PCT2785		1
AUDIO								
DSP04	Audio DSP - 12 Input, 8 Output, AEC, DANTE, USB		-	AV contractor	BiAmp	TesiraFORTE DAN CI		1
AMP20	Power Amplifier - 2Ch, 150Wper Ch,		-	AV contractor	BiAmp	AMP-A460H		1
SPK30	Loudspeaker - Ceiling Recessed 6"	V240	Device installation requires coordination with project General Contractor	AV contractor	Tannoy	CMS 603DC BM		12
MIC40	Gooseneck Microphone 18"		-	AV contractor	Shure	MX418/C		1
WMS02	Wireless Mic - Lavalier Omni/Bodypack/RX		-	AV contractor	Shure	QLXD 14/93		1
DAN02	Netork interface - 2x2 DANTE		-	AV contractor	Shure	ANI22-BLOCK		1
VIDEO								
VTR02	Video Tx\Rx - 4K, 4:4:4, 1 Gig		-	AV contractor	Aurora	VPX-TC1-Pro		7
WSH01	Wireles Sharing Appliance with USB		-	AV contractor	Aurora	TS-100-4F		1
DOCM1	Document Camera, 4K	V179	-	AV contractor	Wolfvisions	VZ8-UHD		1
CONTROL								
CTL02	Control port expander		-	AV contractor	Aurora	LXC-1		2
CTP05	Control Touch Panel - Wired 8"	V156	-	AV contractor	Aurora	RXT-8D-B		1
MISC.								
OFE01	Host PC, Keyboard & Mouse			AV contractor	OFE	OFE		
AVS02	Data Switch - 48 port, 1g,PoE+, 1000w PSU			AV contractor	Netgear	M4300-52G-PoE+		1
USB03	USB Extender			AV contractor	Icron	Starling 3251		1
ERK02	Equipment Rack - 45RU, Pre-Configured for Pro Av	V132		AV contractor	Middle Atlantic	BGR-4527-AV	Located in V108B	1
CCH01	Misc. Wire, Cables, Plates/Panels & Connectors			AV contractor	Custom	By AV Contractor		1

FIT NAB								
High Tech Meeting Room				Room Numbers		N108		
AV SYSTEMS PROCUREMENT								
SYSTEM ID	DESCRIPTION	DRAWING ID	CONSTRUCTION SEQUENCE	FURNISHED BY	MFR	MODEL	NOTES	QTY
DISPLAY								
PRJ02	Video Projector 20000 Lumens With lens	V294	-	AV Contractor	NEC	NP-PX2000UL-47ZL		4
	Projector Mount		Device installation requires coordination with project General Contractor	AV Contractor	Chief	VCMU		4
FPD20	Flatpanel Display - 27" Touch Enabled Desktop		-	AV Contractor	Planar	Helium PCT2785		1
FPD16	Flat Panel Display - 75"	V104	-	AV Contractor	NEC	C751Q	Located in N108A Meeting Space Foyer	1
VIDW01	LED Video wall - 217" 2.5mm 8X8 MGP Install & maintenance	V119	-	AV Contractor	Planar	998-2869-00		1
AUDIO								
DSP04	Audio DSP - 12 Input, 8 Output, AEC, DANTE, USB		-	AV Contractor	BiAmp	TesiraFORTE DAN CI		1
AMP20	Power Amplifier - 2Ch, 150Wper Ch,		-	AV Contractor	BiAmp	AMP-A460H		3
SPK40	Loudspeaker - Pendant coaxial 6"	V245	-	AV Contractor	Tannoy	OCV 6		15
MIC40	Gooseneck Microphone 18"		-	AV Contractor	Shure	MX418/C		1
WMS02	Wireless Mic - Lavalier Omni/Bodypack/RX		-	AV Contractor	Shure	QLXD 14/93		1
WMS01	Wireless Mic - Receiver 4ch.		-	AV Contractor	Shure	ULXD4Q		1
WMS03	Wireless Mic - Handheld Tx Beta58		-	AV Contractor	Shure	ULDxD2/B58		4
IRTX1	ADA - Stationary RF transmitter (Dante)	V220	-	AV Contractor	Listen Tech	LT-800-216-01-D		2
IRRX1	ADA - RF Receiver		-	AV Contractor	Listen Tech	LR-4200-216		10
VIDEO								
VTC01	5 RU 12 Rack Mounting Kit		-	AV Contractor	Aurora	RK2-5-K		1
VTR02	Video Tx/Rx - 4K, 4:4:4, 1 Gig		-	AV Contractor	Aurora	VPX-TC1-Pro		16
WSH01	Wireless Sharing Appliance with USB		-	AV Contractor	Aurora	TS-100-4F		1
DOCM1	Document Camera, 4K	V179	-		Wolfvisions	VZ8-UHD		1
CAM40	Video Camera - PTZ HD 40x zoom 4K	V170	-		Vaddio	Roboshot 40 UHD 4K	999-9952-100W	2
CODEC	Video Codec - Room kit Plus		-		Cisco	CS-CODEC-PLUS		1
CONTROL								
CTL02	Control port expander		-	AV Contractor	Aurora	LXC-1		2
CTP05	Control Touch Panel - Wired 8"	V156	-	AV Contractor	Aurora	RXT-8D-B		1
MISC.								
OFE01	Host PC, Keyboard & Mouse	V122	-		OFE	OFE		
AVS02	Data Switch - 48 port, 1g,PoE+, 1000w PSU		-		Netgear	M4300-52G-PoE+		1
USB03	USB Extender		-		Icron	Starling 3251		3
ERK02	Equipment Rack - 45RU, Pre-Configured for Pro Av	V132	-		Middle Atlantic	BGR-4527-AV		1
CCH01	Misc. Wire, Cables, Plates/Panels & Connectors		-		Custom	By AV Contractor		1

FIT NAB									
Workshop Classrooms					Room Numbers	N208, N308, N408, N708, N808			
AV SYSTEMS PROCUREMENT									
SYSTEM ID	DESCRIPTION	DRAWING ID	CONSTRUCTION SEQUENCE	FURNISHED BY	MFR	MODEL	NOTES	QTY	
DISPLAY									
FPD18	Flat Panel Display - 98"	V106	-	AV Contractor	NEC	C981Q		1	
FPD20	Flatpanel Display - 27" Touch Enabled Desktop		-	AV Contractor	Planar	Helium PCT2785		1	
FPD15	Flat Panel Display - 65"	V103	-	AV Contractor	NEC	M651		1	
FPM03	Flat Panel Display - Wall Mount Tilt Large		-	AV Contractor	Chief	LTM1U		2	
AUDIO									
DSP04	Audio DSP - 12 Input, 8 Output, AEC, DANTE, USB		-	AV Contractor	BiAmp	TesiraFORTE DAN CI		1	
AMP02	Audio Amplifier - 1ch. 120wpc 70V		-	AV Contractor	Labgruppen	LUCIA 120/1-70		1	
SPK30	Loudspeaker - Ceiling Recessed 6"	V240	Device installation requires coordination with project General Contractor	AV Contractor	Tannoy	CMS 603DC BM		8	
DAN02	Netork interface - 2x2 DANTE		-	AV Contractor	Shure	ANI22-BLOCK		1	
MIC40	Gooseneck Microphone 18"	V185	-	AV Contractor	Shure	MX418/C		1	
MIC50	Microphone - Ceiling-Mount, 2'x2' Grid w/ DANTE	V285	-	AV Contractor	Shure	MXA910		2	
WMS02	Wireless Mic - Lavalier Omni/Bodypack/RX		-	AV Contractor	Shure	QLXD 14/93		1	
VIDEO									
CODEC1	Video Codec - Room kit Plus PTZ 4k.	V156 & V170		AV Contractor	Cisco	CS-KITPLPTZ4K-K9	Codec, PTZ Camera & Touch panel	1	
DOCM1	Document Camera, 4K	V179		AV Contractor	Wolfvisions	VZ8-UHD		1	
AVB01	USB CAPTURE HSMI Plus			AV Contractor	Magewell	32040		1	
MTX01	Video Matrix Switcher - 4x2 4K			AV Contractor	Lightware	MMX4x2-HDMI-USB20L	HDMI & USB switching	1	
CAMEX	Camera Extender - Camera extension Kit			AV Contractor	Sound Control Technologies	RC5-CW4		1	
HDTX1	HDBT Transmitter - HDMI			AV Contractor	Lightware	HDMI-TPS-TX86		4	
HDTX2	HDBT Transmitter - HDMI			AV Contractor	Lightware	HDMI-TPS-TX210		1	
HDRX1	HDBT Receiver - HDMI			AV Contractor	Lightware	HDMI-TPS-RX86		3	
CONTROL									
MISC.									
OFE01	Host PC, Keyboard & Mouse			Owner Furnished Contractor Installed	OFE	OFE		1	
AVS01	Data Switch - 24 port, 1g PoE+, 1000w PSU			AV Contractor	Netgear	GSM4328PB-100NES		1	
ERK02	Equipment Rack - 45RU, Pre-Configured for Pro Av	V131		AV Contractor	Middle Atlantic	BGR-4527-AV		1	
CCH01	Misc. Wire, Cables, Plates/Panels & Connectors			AV Contractor	Custom	By AV Contractor		1	

FIT NAB								
Classrooms					Room Numbers		N204, N206, N207, N304, N305, N306, N307, N404, N405, N406, N407, N704, N705, N706, N707, N804, N805, N806, N807	
AV SYSTEMS PROCUREMENT								
SYSTEM ID	DESCRIPTION	DRAWING ID	CONSTRUCTION SEQUENCE	FURNISHED BY	MFR	MODEL	NOTES	QTY
DISPLAY								
FPD18	Flat Panel Display - 98"	V106	-	AV Contractor	NEC	C981Q		1
FPD20	Flatpanel Display - 27" Touch Enabled Desktop		-	AV Contractor	Planar	Helium PCT2785		1
FPD16	Flat Panel Display - 75"	V104	-	AV Contractor	NEC	C751Q		1
FPM03	Flat Panel Display - Wall Mount Tilt Large		-	AV Contractor	Chief	LTM1U		2
AUDIO								
DSP04	Audio DSP - 12 Input, 8 Output, AEC, DANTE, USB		-	AV Contractor	BiAmp	TesiraFORTE DAN CI		1
AMP02	Audio Amplifier - 1ch. 120wpc 70V		-	AV Contractor	Labgruppen	LUCIA 120/1-70		1
SPK30	Loudspeaker - Ceiling Recessed 6"	V240	Device installation requires coordination with project General Contractor	AV Contractor	Tannoy	CMS 603DC BM		6
DAN02	Netork interface - 2x2 DANTE		-	AV Contractor	Shure	ANI22-BLOCK		1
MIC40	Gooseneck Microphone 18"	V185	-	AV Contractor	Shure	MX418/C		1
MIC50	Microphone - Ceiling-Mount, 2'x2' Grid w/ DANTE	V285	-	AV Contractor	Shure	MXA910		2
WMS02	Wireless Mic - Lavalier Omni/Bodypack/RX		-	AV Contractor	Shure	QLXD 14/93		1
VIDEO								
CODEC1	Video Codec - Room kit Plus PTZ 4k.	V156 & V170	-	AV Contractor	Cisco	CS-KITPLPTZ4K-K9	Codec, PTZ Camera & Touch panel	1
DOCM1	Document Camera, 4K	V179	-	AV Contractor	Wolfvisions	VZ8-UHD		1
AVB01	USB CAPTURE HSMI Plus		-	AV Contractor	Magewell	32040		1
MTX01	Video Matrix Switcher - 4x2 4K		-	AV Contractor	Lightware	MMX4x2-HDMI-USB20L	HDMI & USB switching	1
CAMEX	Camera Extender - Camera extension Kit		-	AV Contractor	Sound Control Technologies	RC5-CW4		1
HDTX1	HDBT Transmitter - HDMI		-	AV Contractor	Lightware	HDMI-TPS-TX86		4
HDTX2	HDBT Transmitter - HDMI		-	AV Contractor	Lightware	HDMI-TPS-TX210		1
HDRX1	HDBT Receiver - HDMI		-	AV Contractor	Lightware	HDMI-TPS-RX86		3
CONTROL								
MISC.								
OFE01	Host PC, Keyboard & Mouse		-	Owner Furnished Contractor Installed	OFE	OFE		1
AVS01	Data Switch - 24 port, 1g PoE+, 1000w PSU		-	AV Contractor	Netgear	GSM4328PB-100NES		1
ERK02	Equipment Rack - 45RU, Pre-Configured for Pro Av	V131	-	AV Contractor	Middle Atlantic	BGR-4527-AV		1
CCH01	Misc. Wire, Cables, Plates/Panels & Connectors		-	AV Contractor	Custom	By AV Contractor		1

FIT NAB								
Large Conference Room					Room Numbers		N908	
AV SYSTEMS PROCUREMENT								
SYSTEM ID	DESCRIPTION	DRAWING ID	CONSTRUCTION SEQUENCE	FURNISHED BY	MFR	MODEL	NOTES	QTY
DISPLAY								
FPD17	Flat Panel Display - 86"	V105	-	AV Contractor	NEC	C861Q		1
FPM03	Flat Panel Display - Wall Mount Tilt Large		-	AV Contractor	Chief	LTM1U		1
AUDIO								
DSP04	Audio DSP - 12 Input, 8 Output, AEC, DANTE, USB			AV Contractor	BiAmp	TesiraFORTE DAN CI		1
MIC50	Microphone - Ceiling-Mount, 2'x2' Grid w/ DANTE	V285		AV Contractor	Shure	MXA910		1
VIDEO								
CODEC2	Video Codec - Room kit Plus Quad Cam Kit	V175 & V156		AV Contractor	Cisco	CS-KITPLUS-NR-K9	Codec, Camera Bar & Touch panel	1
QUADXT	Video Codec - Camera Extender Rack-Mount			AV Contractor	Sound Ctrl Tech	RC8-CQC		1
AVB01	USB CAPTURE HSMI Plus			AV Contractor	Magewell	32040		1
MTX01	Video Matrix Switcher - 4x2 4K			AV Contractor	Lightware	MMX4x2-HDMI-USB20L	HDMI & USB switching	1
HDEX1	HDBT Extender - HDMI & USB			AV Contractor	Atlona	AT-OME-EX-KIT	TX & RX INCLUDED	2
HDTX1	HDBT Transmitter - HDMI			AV Contractor	Lightware	HDMI-TPS-TX86		1
HDRX1	HDBT Receiver - HDMI			AV Contractor	Lightware	HDMI-TPS-RX86		1
CONTROL								
MISC.								
CC01	Cable Cubby - Cable access Enclouser for AV connectivity	V117		AV Contractor	Extron	Cable Cubby 222 US 60-1927-02		2
AVS01	Data Switch - 24 port, 1g PoE+, 1000w PSU			AV Contractor	Netgear	GSM4328PB-100NES		1
ERK03	Equipment Rack - Credenza	V130		AV Contractor	Middle Atlantic	CFR-14-20	Provide vent blockers, low-friction runners, power distribution, and all other accessories required.	1
CCH01	Misc. Wire, Cables, Plates/Panels & Connectors			AV Contractor	Custom	By AV Contractor		1

FIT NAB								
Presidents Office				Room Numbers		N900		
AV SYSTEMS PROCUREMENT								
ID	DESCRIPTION	DRAWING ID	CONSTRUCTION SEQUENCE	FURNISHED BY	MFR	MODEL	NOTES	QTY
DISPLAY								
FPD17	Flat Panel Display - 86"		-	AV Contractor	NEC	C861Q		1
FPM03	Flat Panel Display - Wall Mount Tilt Large		-	AV Contractor	Chief	LTM1U		1
AUDIO								
VIDEO								
CODEC3	Video Codec - Room KIT Bar with Touch 10	V175 & V156	-	AV Contractor	Cisco	CS-BAR-T-K9	All in one Codec Camera Bar & Touch Panel	1
TBLEXT	Video Codec - Table extender. HDMI & USB extension		-	AV Contractor	Sound Ctrl Tech	RTK-MINI-2		1
MISC.								
CC01	Cable Cubby - Cable access Enclouser for AV connectivity	V117	-	AV Contractor	Extron	Cable Cubby 222 US 60-1927-02		1
CCH01	Misc. Wire, Cables, Plates/Panels & Connectors		-	AV Contractor	Custom	By AV Contractor		1

FIT NAB								
Student Life Hall				Room Numbers		N503		
AV SYSTEMS PROCUREMENT								
ID	DESCRIPTION	DRAWING ID	CONSTRUCTION SEQUENCE	FURNISHED BY	MFR	MODEL	NOTES	QTY
DISPLAY								
FPD14	Flat Panel Display - 55"	V113		AV Contractor	NEC	M551		6
FPM03	Flat Panel Display - Wall Mount Tilt Large			AV Contractor	Chief	LTM1U		6
AUDIO								
DSP04	Audio DSP - 12 Input, 8 Output, AEC, DANTE, USB			AV Contractor	BiAmp	TesiraFORTE DAN CI		1
AWP01	AV Wallplate - 2x2 XLR, RCA, 3.5mm , 2 Gang	V115		AV Contractor	Attero Tech	unD610		1
AMP20	Power Amplifier - 2Ch, 150Wper Ch,		-	AV Contractor	BiAmp	AMP-A460H		3
SPK30	Loudspeaker - Ceiling Recessed 6"	V240		AV Contractor	Tannoy	CMS 603DC BM		18
WMS02	Wireless Mic - Lavalier Omni/Bodypack/RX			AV Contractor	Shure	QLXD 14/93		1
VIDEO								
VSP01	Digital Signage Player - 4K PoE, with 64GB SD Card			AV Contractor	Brightsign	XT1144	Include 128GB SD Card	6
CONTROL								
CTP05	Control Touch Panel - Wired 8"	V152	-	AV Contractor	Aurora	RXT-8-B		1
MISC.								
OFE01	Host PC, Keyboard & Mouse				OFE	OFE		3
AVS02	Data Switch - 48 port, 1g,PoE+, 1000w PSU			AV Contractor	Netgear	M4300-52G-PoE+		1
ERK03	Equipment Rack - Credenza	V130		AV Contractor	Middle Atlantic	CFR-14-20	Provide vent blockers, low-friction runners, power distribution, and all other accessories required.	1
CCH01	Misc. Wire, Cables, Plates/Panels & Connectors			AV Contractor	Custom	By AV Contractor		1

FIT NAB					
PAGING					
AV SYSTEMS PROCUREMENT					
ID	DESCRIPTION	MFR	MODEL	NOTES	QTY
AUDIO					
	Intercom Chassis	Bogen	PCM2000		1
		Bogen	PCM TIM		1
		Bogen	PCM CPU		1
		Bogen	PCM ZPM		1
	Power supply	Bogen	PCMPS2		1
	110 Block		110 Block		9
	Paging Amplifier	Bogen	TPU250		1
SPK99	8" PA Speaker, 70V Transformer, 4W Max	Bogen	S86T725PG8WBR		110
MISC.					
	Equipment Rack	Chadsworth	11960-706		1
	Rack Kit	Bogen	RPK88		

THESE DOCUMENTS CONTAIN POTENTIALLY SENSITIVE INFORMATION AND SHALL BE USED FOR THEIR INTENDED PURPOSE. ONCE THE INTENDED PURPOSE HAS CEASED, THE DOCUMENTS SHALL BE DESTROYED IN A SECURE MANNER. IF IT IS A VIOLATION OF STATE EDUCATION LAW FOR ANY PERSON, UNLESS UNDER THE DIRECTION OF A LICENSED ARCHITECT/ENGINEER TO ALTER THIS DOCUMENT IN ANY WAY, ALTERATIONS MUST HAVE THE SEAL AFFIXED ALONG WITH A DESCRIPTION OF THE ALTERATIONS, DATE AND ARCHITECT/ENGINEER'S SIGNATURE. COPYRIGHT © 2015

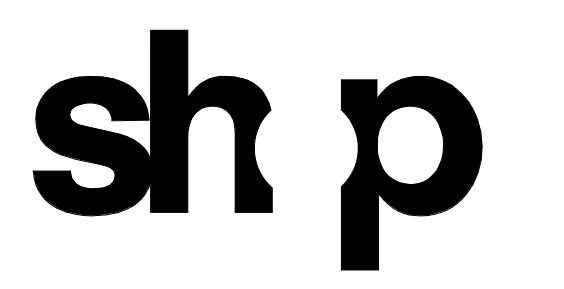

ARCHITECT	
SHoP ARCHITECTS 233 BROADWAY 11TH FLOOR NEW YORK, NY 10019 NY 212.334.2025	
STRUCTURAL ENGINEER	FAÇADE CONSULTANT
BURCHAPPOLD 100 BROADWAY NEW YORK, NY 10005 NY 212.334.2025	WERNER SOBEK 138 SPRING ST NEW YORK, NY 10012 NY 212.586.2033
MEP ENGINEER	LIGHTING
BURCHAPPOLD 100 BROADWAY NEW YORK, NY 10005 NY 212.334.2025	TILLOTSON DESIGN ASSOCIATES 40 WORTH ST SUITE 703 NEW YORK, NY 10013 NY 212.576.7760
MEP ENGINEER	SIGNAGE
SPK + M 134 W 27TH ST 10TH FLOOR NEW YORK, NY 10011 NY 212.752.7200	VIA COLLECTIVE 394 DEAN ST BROOKLYN, NY 11228 NY 347.689.4373
CIVIL ENGINEER	VERTICAL TRANSPORTATION
PHILIP HABIB & ASSOCIATES 102 MADISON AVENUE 11TH FLOOR NEW YORK, NY 10016 NY 212.522.6556	VAN DELUSEN & ASSOCIATES 145 W 30TH ST NEW YORK, NY 10018 NY 212.387.2707
LANDSCAPE	EXPEDITER
MATTHEWS NIELSEN 130 BROADWAY SUITE 1040 NEW YORK, NY 10013 NY 212.491.2609	MUNICIPAL EXPEDITING INC 15 MADISON LANE NEW YORK, NY 10008 NY 212.387.2707
GEOTECHNICAL	FOOD SERVICE
SCHNABEL ENGINEERING 1380 WILMINGTON PIKE SUITE 100 WEST CHESTER PA 19380 PA 610.696.6006	HICKS DESIGN GROUP 202 WEST 40TH ST SUITE 402 NEW YORK, NY 10018 NY 212.575.1777
CODE AND FIRE	DOOR HARDWARE
BURCHAPPOLD 100 BROADWAY NEW YORK, NY 10005 NY 212.334.2025	TEBT ARCHITECTURAL HARDWARE COMPANY 188 FOX DEN DR LENOXVILLE, NC 27566 NC 336.775.1535
AV, IT, SECURITY & ACOUSTICAL	BUILDING MAINTENANCE
SM&W 417 FIFTH AVE NEW YORK, NY 10018 NY 212.725.8800	ENTEX ENGINEERING 100 AMES ST MACKENZIE, NJ 07061 NJ 201.830.2802

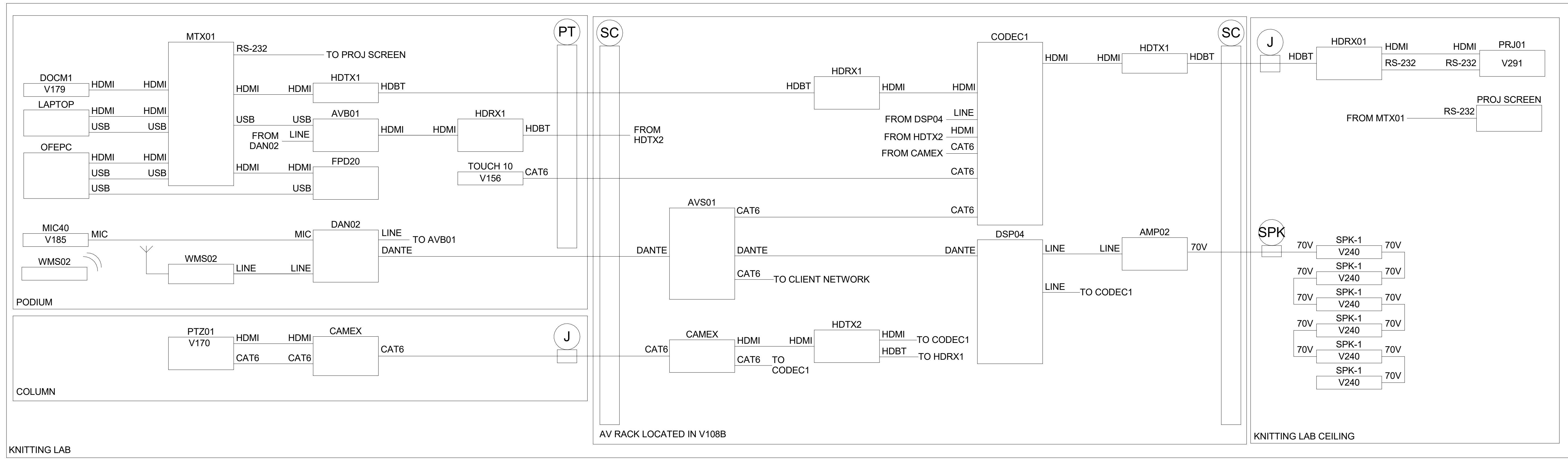

1 AUDIOVISUAL SYSTEM DIAGRAM - KNITTING LAB
 NO SCALE

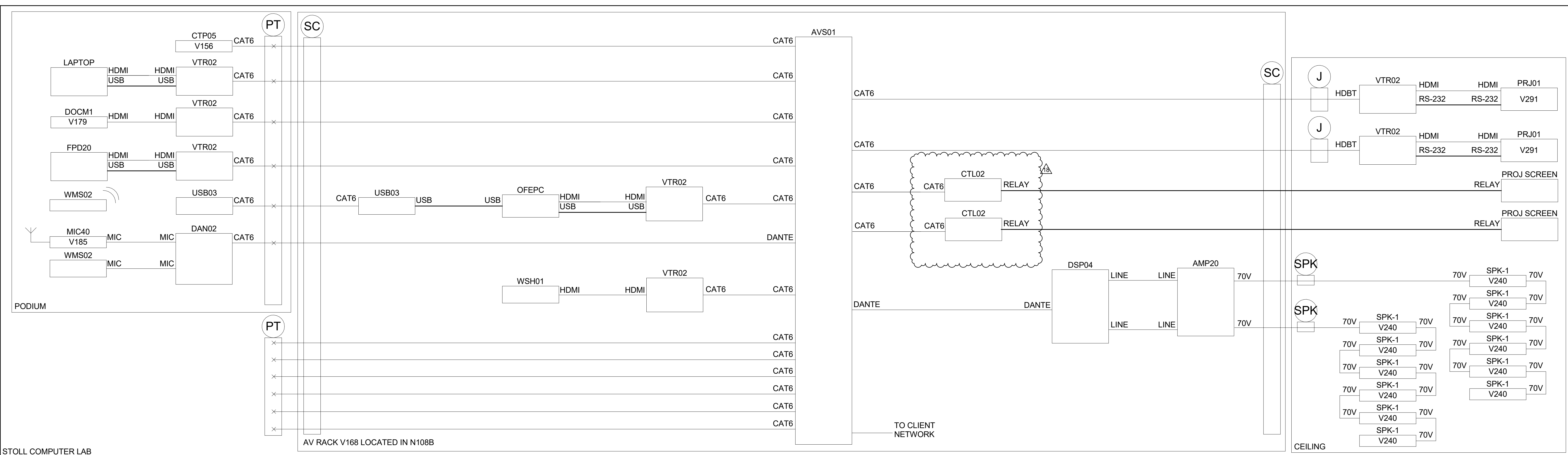

2 AUDIOVISUAL SYSTEM DIAGRAM - STOLL COMPUTER LAB
 NO SCALE



FASHION INSTITUTE OF TECHNOLOGY
 207-243 WEST 27TH STREET
 NEW YORK, NY 10001

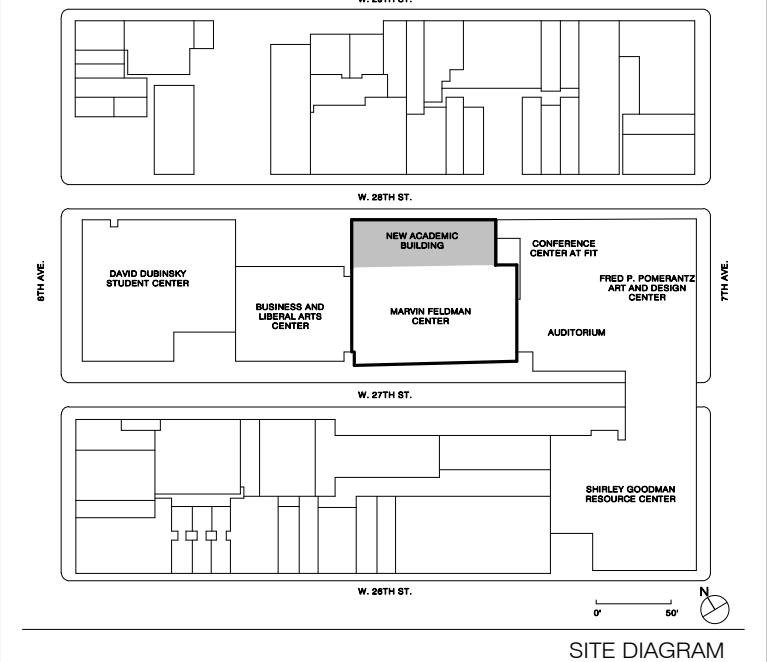

NO.	ISSUE	DATE
18	ADDENDUM 1	01/10/2013
17	AV SYSTEMS PROCUREMENT	11/16/2012
16	Final PFE Submission	11/15/2012
15	Cost Submission 90%	09/20/2012
14	10% Concept design by review	07/19/2012
13	CONTRACT & BULLETIN #8	06/06/2012
12	10% CONSTRUCTION DOCUMENTS	06/13/2011
11	30% CONSTRUCTION DOCUMENTS	10/01/2010

THESE DRAWINGS ARE INSTRUMENTS OF SERVICE AND AS SUCH MAY NOT BE USED FOR OTHER PROJECTS, FOR ADDITIONS TO THIS PROJECT OR COMPLETION OF THIS PROJECT BY OTHERS.
 COPYRIGHT © 2017 SHoP ARCHITECTS PC. ALL RIGHTS RESERVED.

NOT FOR CONSTRUCTION

DRAWING TITLE
AUDIOVISUAL SYSTEM BLOCK DIAGRAM - KNITTING LAB & STOLL COMPUTER LAB

SEAL & SIGNATURE	DATE	2/1/2023
	PROJECT NO.	16202
	DRAWN BY	Author
	CHECKED BY	Checker
	DOB NO.	
	DRAWING NUMBER	

TA-500.00

THESE DOCUMENTS CONTAIN POTENTIALLY SENSITIVE INFORMATION AND SHALL BE USED FOR THEIR INTENDED PURPOSE. ONCE THE INTENDED PURPOSE HAS CEASED, THE DOCUMENTS SHALL BE DESTROYED IN A SECURE MANNER. IT IS A VIOLATION OF STATE EDUCATION LAW FOR ANY PERSON, UNLESS UNDER THE DIRECTION OF A LICENSED ARCHITECT/ENGINEER TO ALTER THIS DOCUMENT IN ANY WAY. ALTERATIONS MUST HAVE THE SEAL AFFIXED ALONG WITH A DESCRIPTION OF THE ALTERATIONS, DATE AND ARCHITECT/ENGINEER'S SIGNATURE. COPYRIGHT © 2015

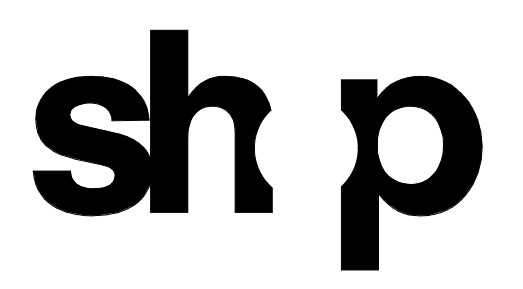

ARCHITECT	
SHoP ARCHITECTS 233 BROADWAY 11TH FLOOR NEW YORK, NY 10028 NY 212.889.8005	
STRUCTURAL ENGINEER	FAÇADE CONSULTANT
BURCHAPPOLD 100 BROADWAY NEW YORK, NY 10005 NY 212.334.2025	WERNER SOBEK 138 SPRING ST NEW YORK, NY 10012 NY 212.598.2033
MEP ENGINEER	LIGHTING
BURCHAPPOLD 100 BROADWAY NEW YORK, NY 10005 NY 212.334.2025	TILLOTSON DESIGN ASSOCIATES 40 WEST ST SUITE 703 NEW YORK, NY 10013 NY 212.676.7760
MEP ENGINEER	SIGNAGE
JFK + M 134 W 37TH ST 10TH FLOOR NEW YORK, NY 10018 NY 212.752.7200	VIA COLLECTIVE 394 DEAN ST BROOKLYN, NY 11228 NY 646.209.4373
CIVIL ENGINEER	VERTICAL TRANSPORTATION
PHILIP HABIS & ASSOCIATES 102 MADISON AVENUE 11TH FLOOR NEW YORK, NY 10016 NY 212.922.6566	VAN DEUSEN & ASSOCIATES 145 W 30TH ST NEW YORK, NY 10001 NY 878.664.8220
LANDSCAPE	EXPEDITER
MATTHEWS NIELSEN 130 BROADWAY SUITE 1040 NEW YORK, NY 10013 NY 212.491.2609	MUNICIPAL EXPEDITING INC 15 MADEN LANE NEW YORK, NY 10008 NY 212.387.2707
GEOTECHNICAL	FOOD SERVICE
SCHNABEL ENGINEERING 1380 WILMINGTON PIKE SUITE 100 WEST CHESTER PA 19380 PA 610.696.6006	HICKS DESIGN GROUP 202 WEST 40TH ST SUITE 402 NEW YORK, NY 10018 NY 212.575.1777
CODE AND FIRE	DOOR HARDWARE
BURCHAPPOLD 100 BROADWAY NEW YORK, NY 10005 NY 212.334.2025	T&B ARCHITECTURAL HARDWARE COMPANY 188 FOX DEN DR LENOXVILLE, NC 27645 NC 336.775.1535
AV, IT, SECURITY & ACUSTICAL	BUILDING MAINTENANCE
SM&W 417 FIFTH AVE NEW YORK, NY 10018 NY 212.725.6800	ENTEK ENGINEERING 100 AMES ST RACKONNAC, IL 62601 IL 301.830.2802

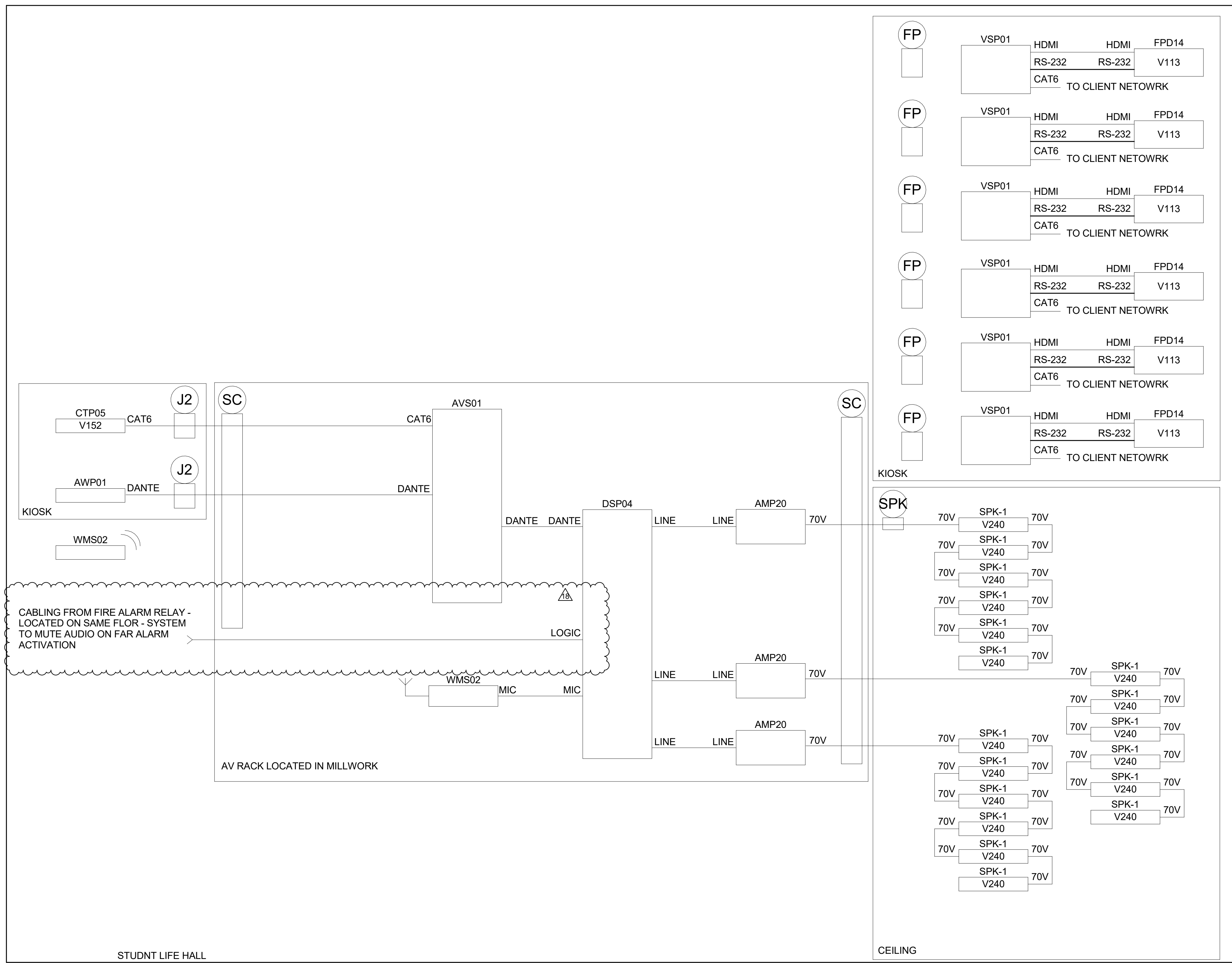

1 AUDIOVISUAL SYSTEM DIAGRAM - STUDENT LIFE HALL
 NO SCALE

FIT NEW ACADEMIC BUILDING
 FASHION INSTITUTE OF TECHNOLOGY
 207-243 WEST 27TH STREET
 NEW YORK, NY 10001

SITE DIAGRAM

18	ADDENDUM 1	01/10/2023
17	AV SYSTEMS PROCUREMENT	11/16/2022
16	Final PFE Submission	11/15/2022
15	Cost Submission 90%	09/20/2022
14	10% Concept design by review	07/19/2021
13	CONTRACT #1144111111	06/09/2021
12	75% CONSTRUCTION DOCUMENTS	06/13/2019
11	35% CONSTRUCTION DOCUMENTS	03/07/2019

NO.	ISSUE	DATE
-----	-------	------

THESE DRAWINGS ARE INSTRUMENTS OF SERVICE AND AS SUCH MAY NOT BE USED FOR OTHER PROJECTS, FOR ADDITIONS TO THIS PROJECT OR COMPLETION OF THIS PROJECT BY OTHERS.
 COPYRIGHT © 2017 SHoP ARCHITECTS PC. ALL RIGHTS RESERVED.

NOT FOR CONSTRUCTION

DRAWING TITLE	
AUDIOVISUAL SYSTEM BLOCK DIAGRAM - STUDENT LIFE HALL	
SEAL & SIGNATURE	DATE
	2/1/2023
DRAWN BY	PROJECT NO.
CHECKED BY	Author
DOE NO.	Checker
DRAWING NUMBER	

TA-501.00

THESE DOCUMENTS CONTAIN POTENTIALLY SENSITIVE INFORMATION AND SHALL BE USED FOR THEIR INTENDED PURPOSE. ONCE THE INTENDED PURPOSE HAS CEASED, THE DOCUMENTS SHALL BE DESTROYED IN A SECURE MANNER. IF IN VIOLATION OF STATE EDUCATION LAW FOR ANY PERSON, UNLESS UNDER THE DIRECTION OF A LICENSED ARCHITECT/ENGINEER TO ALTER THIS DOCUMENT IN ANY WAY, ALTERATIONS MUST HAVE THE SEAL AFFIXED ALONG WITH A DESCRIPTION OF THE ALTERATIONS, DATE AND ARCHITECT/ENGINEER'S SIGNATURE. COPYRIGHT © 2015



ARCHITECT	
SHoP ARCHITECTS 233 BROADWAY 11TH FLOOR NEW YORK, NY 10028 PH: 212.889.8005	
STRUCTURAL ENGINEER	FAÇADE CONSULTANT
BURCHAPPOLD 100 BROADWAY NEW YORK, NY 10005 PH: 212.334.2025	WERNER SOBEK 138 SPRING ST NEW YORK, NY 10012 PH: 212.586.2033
MEP ENGINEER	LIGHTING
BURCHAPPOLD 100 BROADWAY NEW YORK, NY 10005 PH: 212.334.2025	TILLOTSON DESIGN ASSOCIATES 40 WEST 47TH ST. SUITE 303 NEW YORK, NY 10013 PH: 212.676.7760
MEP ENGINEER	SIGNAGE
JFK + M 134 W 37TH ST. 10TH FLOOR NEW YORK, NY 10018 PH: 212.752.7020	VIA COLLECTIVE 394 DEAN ST BROOKLYN, NY 11228 PH: 718.859.4033
CIVIL ENGINEER	VERTICAL TRANSPORTATION
PHILIP HABIB & ASSOCIATES 102 MADISON AVENUE, 11TH FLOOR NEW YORK, NY 10017 PH: 212.502.6566	VAN DEUSEN & ASSOCIATES 145 W 30TH ST NEW YORK, NY 10001 PH: 877.664.6020
LANDSCAPE	EXPEDITER
MATTHEWS NIELSEN 130 BROADWAY SUITE 1040 NEW YORK, NY 10013 PH: 212.491.8099	MUNICIPAL EXPEDITING INC NEW YORK, NY 10008 PH: 212.387.2707
GEOTECHNICAL	FOOD SERVICE
SCHNABEL ENGINEERING 1380 WILMINGTON PIKE, SUITE 100 WEST CHESTER, PA 19380 PH: 610.696.6006	HICKS DESIGN GROUP 202 WEST 40TH ST, SUITE 402 NEW YORK, NY 10018 PH: 212.575.1777
CODE AND FIRE	DOOR HARDWARE
BURCHAPPOLD 100 BROADWAY NEW YORK, NY 10005 PH: 212.334.2025	T&B ARCHITECTURAL HARDWARE COMPANY 188 FOX DEN DR LENOXVILLE, NC 27564 PH: 336.775.1535
AV, IT, SECURITY & ACOUSTICAL	BUILDING MAINTENANCE
SM&W 417 FIFTH AVE NEW YORK, NY 10018 PH: 212.725.8800	ENTEK ENGINEERING 160 AMES ST MACKENZIE, NJ 07061 PH: 201.830.2802

NEW ACADEMIC BUILDING
 FASHION INSTITUTE OF TECHNOLOGY
 207-243 WEST 27TH STREET
 NEW YORK, NY 10001

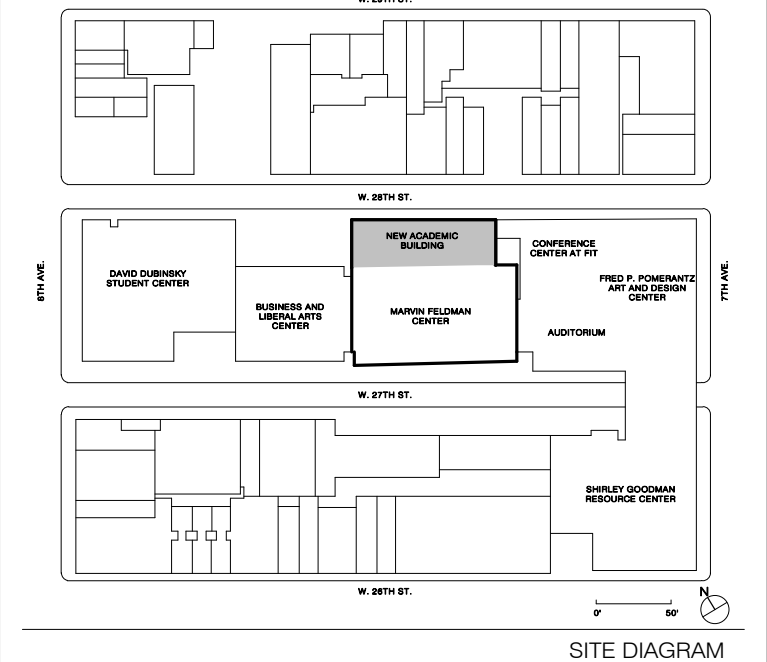

18 - ADDENDUM 1	01/10/2023
17 - AV SYSTEMS PROCUREMENT	11/16/2022
16 - Final PFE Submission	11/15/2022
15 - Cost Submission 90%	09/20/2022
14 - 50% Concept Design for review	07/19/2022
13 - CONTRACT #1 BULLETIN #1	06/06/2022
12 - 10% CONSTRUCTION DOCUMENTS	04/13/2022
11 - 30% CONSTRUCTION DOCUMENTS	03/07/2022

THESE DRAWINGS ARE INSTRUMENTS OF SERVICE AND AS SUCH MAY NOT BE USED FOR OTHER PROJECTS, FOR ADDITIONS TO THIS PROJECT OR COMPLETION OF THIS PROJECT BY OTHERS.
 COPYRIGHT © 2017 SHoP ARCHITECTS PC. ALL RIGHTS RESERVED.

NOT FOR CONSTRUCTION

DRAWING TITLE	
AUDIOVISUAL SYSTEM BLOCK DIAGRAM - HIGHTECH MEETING ROOM	
SEAL & SIGNATURE	DATE
	2/1/2023
PROJECT NO.	14202
DRAWN BY	FL
CHECKED BY	PB
DOB NO.	
DRAWING NUMBER	

TA-503.00

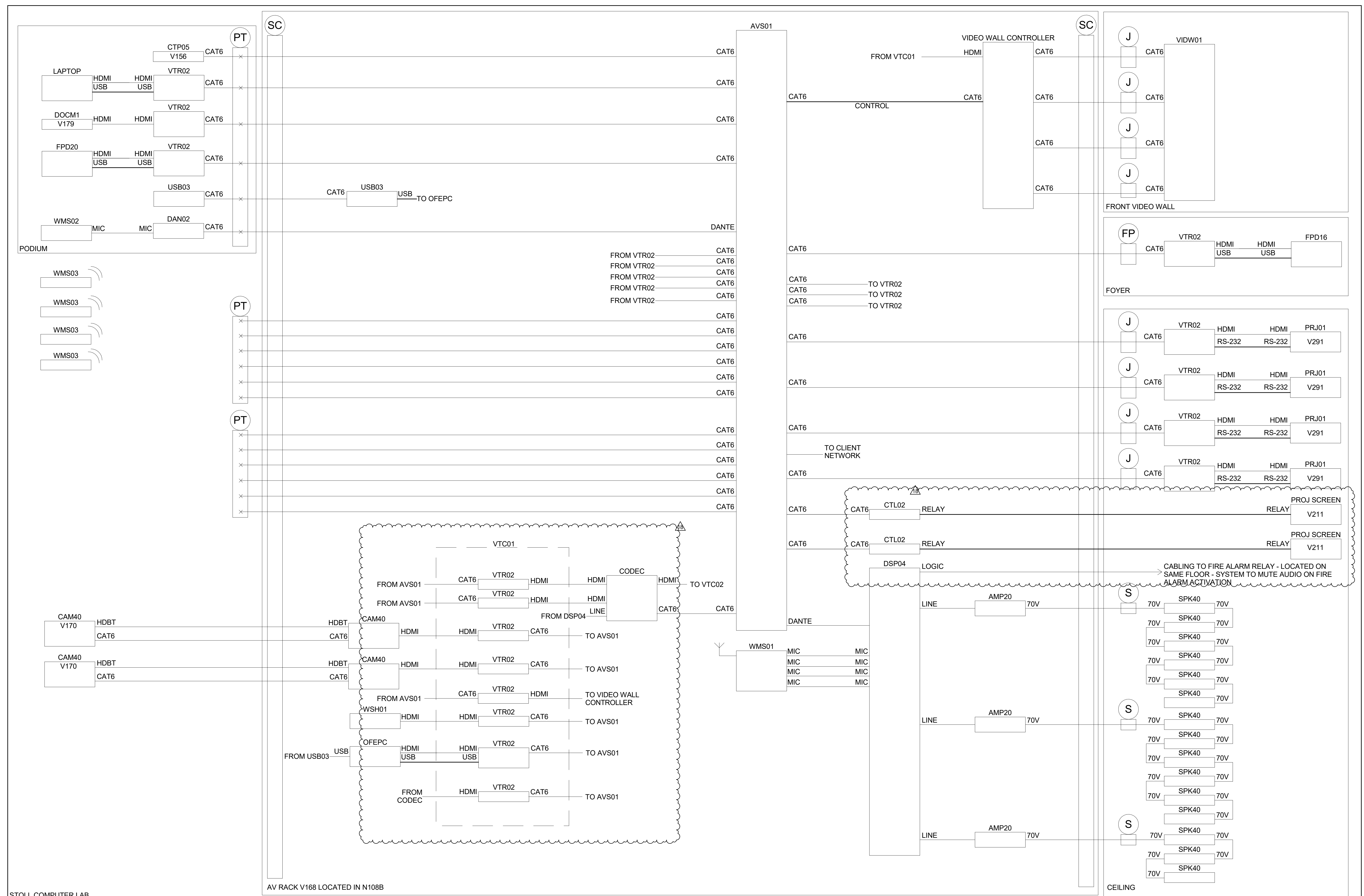

1 AUDIOVISUAL SYSTEM DIAGRAM - HIGHTECH MEETING SPACE
 NO SCALE

STOLL COMPUTER LAB

AV RACK V168 LOCATED IN N108B

2/1/2023 2:28:30 PM