

BIDDING REQUIREMENTS for PURCHASING

NOTICE AND INFORMATION FOR BIDDERS

Attachment A: Bid Breakdown & Schedule

Bidder:

DASNY Contact: Stacie Craft (518) 257-3085 scraft@dasny.org

Services/Product Required By: As Soon As Possible Based on Product Leadtime's

Description: Furnish and Deliver Door Hardware

Bid Open Location: DASNY, Corporate Headquarters, 515 Broadway, Albany, NY 12207

Bid Open Date and Time: February 25, 2022 @ 2:30 p.m.

Item No.	Manufacturer	Make/Model	Description	QTY	UOM	Unit Price	Extended Price
1	Corbin Russwin as specified	ML2057-LL-630	Storeroom Lever Mortise Body	100	EA	\$	\$
2	Corbin Russwin as specified	ML2055-LL-630	Classroom Lever Mortise Body	100	EA	\$	\$
3	Corbin Russwin as specified	ML20932-LL- 630-SEC-M91x M92	Elec. Knob X RX Switch - Grade 1 Fail Secure Electrified Mortise Lock	100	EA	\$	\$
4			Freight/Shipping		LS	\$	\$

INSTALLATION LABOR
LABOR TO INSTALL Not Applicable

Estimated No. of Hours Not Applicable

Hourly Rate (*Prevailing Wage rates are not required for this work*) Not Applicable

Total Materials/Equipment/Commodities: _____

Total Installation: Not Applicable

TOTAL BID _____

BIDDING REQUIREMENTS for PURCHASING

NOTICE AND INFORMATION FOR BIDDERS

(The below questions 1) and 2) need only be answered if the above total bid is for one million dollars or more)

- 1. Does your firm anticipate the use of subcontractors and outside suppliers specific to this procurement
Yes No
- 2. Does your firm anticipate the creation of employment opportunities arising from this procurement?
Yes No

(The below information must be completed for all bids.)

Identify all subcontractors, if any: _____

STATE, PROVINCE FOR FOREIGN COUNTRY
THAT YOUR FIRM'S PRINCIPAL PLACE OF
BUSINESS IS LOCATED:

ADDRESS OF FACTORY OR PLANT WHERE
ITEMS ARE MANUFACTURED AND/OR
ASSEMBLED. (Attach additional sheet(s) if more
than one manufacturer)

BIDDER (FIRM NAME)

SIGNATURE

NAME (TYPE/PRINTED)

TITLE

Date

BIDDING REQUIREMENTS for PURCHASING

NOTICE AND INFORMATION FOR BIDDERS

Attachment B: Detailed Specifications

Equipment to be provided:

Model No.	Description:	Qty.
ML2057-LL-630	Corbin Russwin PA Storeroom Lever Mortise Body (700F098) Note: Single Cylinder Function	100
ML2055-LL-630	Corbin Russwin PA Classroom Lever Mortise Body (700F088) Note: Single Cylinder Function	100
ML20932-LL-630-SEC-M91x M92	Elec. Knob X RX Switch - Grade 1 Fail Secure Electrified Mortise Lock	100

Notes:

1. See attached Corbin Russwin Product Specification Sheets.
2. The handle type is the standard is LWA Style.
3. The lock bodies are not impacted whether it's left handed (LH) or right handed (RH).



Always The Right Fit



EcoFlex®



EcoFlex®, available in Corbin Russwin electrified mortise locks, represents a significant innovation in door opening technology. The EcoFlex® electrified mortise lock is ideal for access control applications, whether it's used in conjunction with a wall reader, in an integrated hardwired lock, or in an integrated battery powered lock.

Experience a safer
and more open world

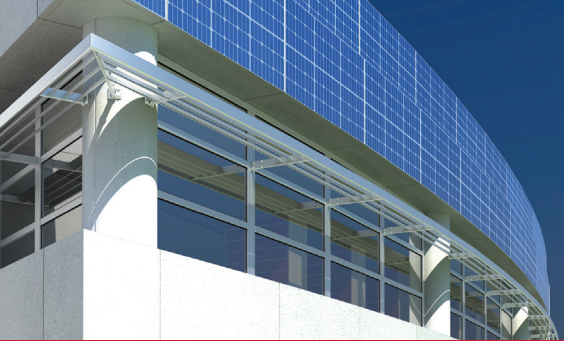

EcoFlex[®]

Efficient. Flexible. Dependable.

TECHNICAL SPECIFICATIONS:

12V or 24V applications

- 500mA lock body peak current draw
- 15mA lock body holding current draw*

*Approximately 5% of an equivalent solenoid

AVAILABLE IN

- Electrified mortise locks
- Access 600[®] RNE1 Integrated Wiegand mortise locks
- Access 700[®] PIP1 PoE mortise locks
- Access 700[®] PWI1 WiFi mortise locks
- Access 800[®] AC2 offline mortise locks
- Access 800[®] IP1 PoE mortise locks
- Access 800[®] WI1 WiFi mortise locks
- IN120 WiFi mortise locks
- SE LP10 Integrated Wiegand mortise locks



In fail-safe applications, such as stairwells, the EcoFlex[®] electrified mortise lock offers a potential savings of 50kWh per opening

Features	Benefits
ANSI/BHMA Grade 1 certified mortise lock	• Strength and durability; assurance of high quality hardware
Reduced energy consumption and product sustainability measures	• Up to 96% energy savings, as certified by Green Circle • Lower operating costs • Assists with load reduction in optimizing energy performance credit in LEED • Reduces number of power supplies required for hard-wired locks • Improves battery life for offline locks
Field configurable to fail-safe or fail-secure	• A single lock body can be used for a variety of applications throughout a facility – Simplifies ordering – Reduces stocking requirements with one flexible lock – Offers greater flexibility to adapt to changing requirements
Ability to operate from 12 volts to 24 volts	• Greater flexibility in system design
Innovative actuator design	• Superior reliability – Higher performance and reduced maintenance – Ability to have longer cable runs without negatively impacting lock function – Reduces risk of voltage drops and eliminates inductive kickback – Lower total cost of ownership
Available with a wide range of finishes and decorative levers	• Blends into any environment seamlessly



Corbin Russwin Architectural Hardware
225 Episcopal Road, Berlin, CT 06037
Phone 800-543-3658
Fax 800-447-6714
www.corbinrusswin.com

ASSA ABLOY Door Security Solutions Canada
160 Four Valley Drive, Vaughan, Ontario, Canada L4K 4T9
Phone: 800-461-3007
Fax: 800-461-8989
www.assaabloydss.ca

The ASSA ABLOY Group is the global leader in access solutions. Every day we help people feel safe, secure and experience a more open world.



ML2000 Series Mortise Locksets



Product Catalog

Experience a safer
and more open world

Overview

ML2000 Series

Table of Contents

ML2000 Series Overview	2
ML2000 Series Features	3-4
ML2000 Series Functions	5-9
Multi-Function Configuration	10-11
ML20900 ECL Applications ...	12
ML20900 ECL Features	14
ML20900 ECL Functions ..	15-16
ML20600 NAC Series Electrified Mortise Lock with High Security Monitoring	17
NAC Functions.....	18-19
Trim Designs	20-39
Muséo® Levers	40-52
Vineyard™ Collection Trim.....	53-55
Museo® Rose/Escutcheon Designs.....	56
Muséo® Inspire™ Roseless Trim	57
Behavioral Health Trim (BHSS).....	58
Behavioral Health Lever Trim (BLSS)	59
Push/Pull Trim (HPSK).....	60
Anti-Harm Trim (HSS).....	61
Vandal Reistant Trim (VR)	62
Indicators	63-68
Options and Accessories....	69-75
How to Order	76-78
Finishes.....	79
Quick Codes	79-82
How to Specify	83-85
Reversing Handing	86

www.corbinrusswin.com

Quality

The ML2000 Series is a Grade 1 mortise lock designed to meet the rigors of high-traffic commercial, institutional, industrial and government applications. Constructed of heavy-gauge steel, the lockbody features our patented Quick Reversible latchbolt, and a 1" stainless steel deadbolt. A wide variety of trim designs and functions and a 10-year warranty lend to the ML2000's versatility and reliability, making it the ideal choice for use in offices, schools, hospitals, hotels and other high-use applications.

Security

Further discourage intrusion and abuse with the ML2000VR (Vandal Resistant) series mortise lock. This lock features vandal-resistant stainless steel escutcheons with tapered edges and Torx® pin tamper resistant screws. When matched with Corbin Russwin patented high-security cylinders, any door can become a formidable barrier to intruders.

Flexible

The ML2000 Series has a multi-function capability, allowing 12 functions to be configured from one lockbody. The ML2054 entrance function (ANSI F04) uses a universal lockbody with the ability to reconfigure into other functions without dissembling the lock case.

Aesthetics

Complement any application with the full range of trim designs and finishes offered with ML2000 Series. From stainless steel security trims to bright brass Vineyard™ levers, design continuum can be achieved without forfeiting aesthetics. For additional information regarding designer trim, see the Corbin Russwin Vineyard™ Collection and Muséo® Collection catalogs.

Key Advantages

- Patented Quick Reversible feature enables reversal of hands without disassembling the lock case (Patent pending and/or patent www.assaabloydss.com/patents)
- Security trims provide a vandal-resistant barrier
- Can be used with new or existing Corbin Russwin key systems. Also accepts cylinders of most other manufacturers.
- Provides life safety and security in a single door prep, saving the additional cost of a deadlock
- Thru-bolted trim designs for proper alignment and increased security
- Multi-function lockbody
- Status indicator options provide peace of mind on the locked/unlocked status of a door

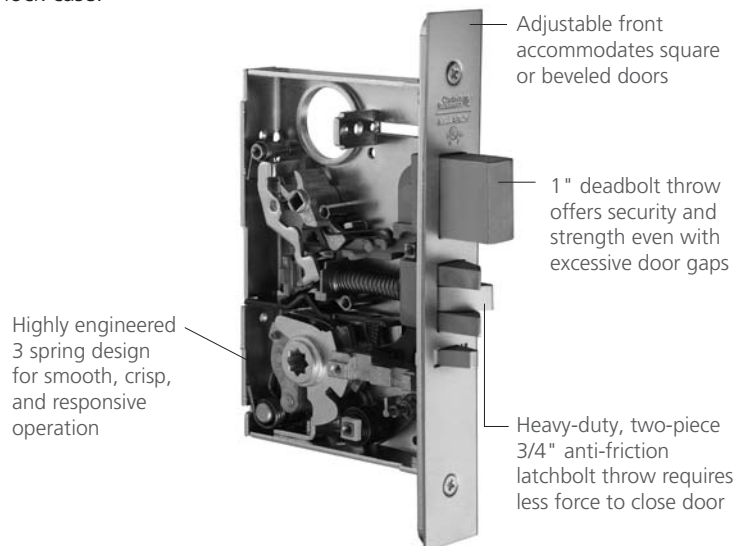

Features

Handing

Handed; quick reversible. The lockset can be re-handed without disassembling the lock case; see page 86.

Door Thickness

1-3/4" (44mm) standard.
Optional door thicknesses available; see Quick Codes, page 80.

Backset

2-3/4" (70mm).

Lockcase

Heavy-gauge steel, 5-7/8" (149mm) x 4" (102mm) x 15/16" (24mm).
Optional: non-ferrous lockcase for corrosion resistance; see Quick Codes, page 80.

Front

Heavy-gauge steel, 8" (203mm) x 1-1/4" (32mm) x -3/32" (2mm). Accommodates flat doors and doors beveled 1/8" (3mm) in 2" (51mm). Furnished 1-1/16" (27mm), optional D138, wide for 1-3/8" (35mm) doors.

Armored Front

Wrought brass, bronze or stainless steel attached by machine screws to lockcase front. ML2000VR utilizes security Torx® screws.

Latchbolt

2-piece mechanical with anti-friction insert, 5/8" (16mm) x 1" (25mm) x 3/4" (19mm) throw.

Auxiliary Latchbolt

9/16" (14mm) effective throw and 3/8" (10mm) effective auxiliary latch deadlocking.

Deadbolt

One-piece stainless steel, 19/32" (15mm) x 1-1/4" (32mm) x 1" (25mm) throw.

Indicators

Status indicators available in sectional or escutcheon trim with many options providing clarity of the locked/unlocked status of a door.

Hub

Standard knob/lever hub is steel, 5/16" (8mm)

Spacing

C. to c. knob/lever to cylinder: 3-5/8" (92mm).

C. to c. knob/lever to thumbturn: 2-7/16" (62mm).

Strike

Wrought brass, bronze or stainless steel, ANSI straight lip standard, 4-7/8" (124mm) x 1-1/4" (32mm) x 1-1/8" (29mm) lip to center. Optional strikes, lip lengths and ANSI wrought strike box available; see Quick Codes, page 80.

Cylinder

Brass, 6-pin, L4 keyway, 0-bitted standard. Optional cylinders available; see Quick Codes, page 72.

Keys

Two nickel silver standard.

Keying Features Available

Master keying
Construction master keying
Visual key control
Concealed key control
Plug only to show (concealed shell)
7-pin cylinder
Security cylinder
Access 3® cylinder
Pyramid cylinder
Interchangeable core (LFIC or SFIC)
Security LFIC
Pyramid LFIC
Access 3® LFIC
Master ring cylinder
Flex head cylinder

Warranty

Ten-year limited.

Certification/Compliance*

ANSI/BHMA

Certified A156.13 Series 1000, Operational and Security Grade 1. Meets A117.1 Accessibility Code.



UL/cUL-UL10C Positive Pressure

All locks listed for A label and lesser class doors, 4' (122cm) x 10' (305cm) single or 8' (244cm) x 10' (305cm) pair (3 hour fire door). Letter F and UL symbol on armored front indicate listing.

Any retrofit or other field modification to a fire rated opening can potentially impact the fire rating of the opening, and Corbin Russwin, Inc. makes no representations or warranties concerning what such impact may be in any specific situation. When retrofitting any portion of an existing fire-rated opening, or specifying and installing a new fire-rated opening, please consult with a code specialist or local code official (Authority Having Jurisdiction) to ensure compliance with all applicable codes and ratings.

California State Reference Code

(Formerly Title 19, California State Fire Marshal Standard)

All levers with returns, return to within 1/2" (13mm) of door face.













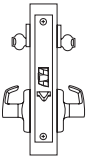



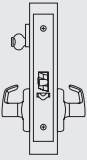

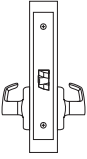

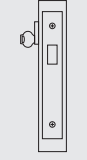
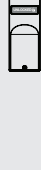

Windstorm/Hurricane

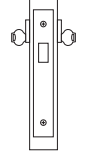
Certified (refer to local codes).

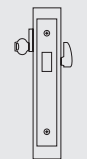
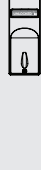

*Any undated reference to a code or standard appearing in the this catalog shall be interpreted as referring to the latest edition of that code or standard.

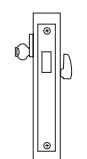
Functions

ML2000 Series

Outside	Inside	Function (ANSI No.)	Type	Function Description
  A01	  A01	ML2002	Classroom Intruder	<ul style="list-style-type: none"> Latchbolt by grip either side, unless outside grip is locked by key either side. Outside grip locked or unlocked by cylinder either side. Auxiliary latch deadlocks latchbolt. Inside grip always free.
  A01	 	ML2003	Classroom	<ul style="list-style-type: none"> Lock or unlock outside grip by key. Latchbolt by grip either side, unless outside grip is locked. Inside grip always free. Auxiliary latch deadlocks latch.
	 	ML2010 (F01)	Passage or Closet	<ul style="list-style-type: none"> Latchbolt by grip either side. Both grips always free.
  A01	 	ML2011 (F18)	Deadlock	<ul style="list-style-type: none"> Deadbolt by key outside. No inside operation. <p>Note: Indicators available for sectional trim only.</p>
  A01	  A01	ML2012 (F16)	Deadlock	<ul style="list-style-type: none"> Deadbolt by key either side. <p>Note: Indicators available for sectional trim only.</p>
  A01	 	ML2013 (F17)	Deadlock	<ul style="list-style-type: none"> Deadbolt by key outside or by thumbturn grip inside. <p>Note: Indicators available for sectional trim only.</p>
  A01	 	ML2017 (F29)	Classroom Deadlock	<ul style="list-style-type: none"> Deadbolt by key outside. Thumbturn grip inside retracts deadbolt only; will not project deadbolt.











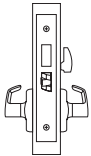

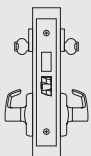

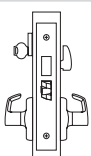
 Indicator options available for both sectional and escutcheon trim.

 Cylinder cam required.
 Indicates rigid grip.

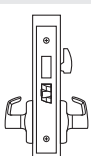
* When lever handles are furnished, both outside and inside are locked when deadbolt is projected.

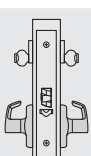
Functions

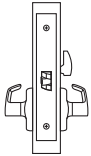
ML2000 Series

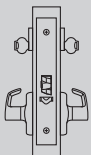
Outside	Inside	Function (ANSI No.)	Type	Function Description
		ML2020 (F02)	Privacy Bedroom or Bathroom	<ul style="list-style-type: none"> Latchbolt by grip* either side, when deadbolt is retracted. Deadbolt by thumbturn grip inside or by emergency release tool outside. No simultaneous deadbolt and latch retraction. Non-panic release. Not available with M19S or M19SN.
 A01		ML2022 (F14)	Store Door	<ul style="list-style-type: none"> Latchbolt by grip* either side when deadbolt is retracted. Deadbolt by key either side. Latchbolt retracted by key either side. Non-panic release. No simultaneous deadbolt and latch retraction.
 A01		ML2024 (F21)	Entrance or Storeroom	<ul style="list-style-type: none"> Latchbolt by grip* either side when deadbolt is retracted. Deadbolt by key outside or by thumbturn grip inside. Latchbolt retracted by key outside. Non-panic release. No simultaneous deadbolt and latch retraction.
 A01		ML2029 (F15)	Hotel or Motel	<ul style="list-style-type: none"> Latchbolt by grip inside and by guest key or master key outside. Outside grip always rigid. Deadbolt by thumbturn grip inside or by emergency key outside. Inside grip simultaneously retracts latchbolt and deadbolt. Emergency key shuts out all other keys. Auxiliary latch deadlocks latchbolt. <p>Note: Indicator shows deadbolt position only.</p>
		ML2030 (F19)	Privacy Bedroom or Bathroom	<ul style="list-style-type: none"> Latchbolt by grip either side unless outside grip locked by thumbturn. Deadbolt by thumbturn grip inside or by emergency release tool outside. Inside grip simultaneously retracts latchbolt and deadbolt and unlocks outside grip. Not available with M19S or M19SN.
 A01		ML2032 (F30)	Institution or Utility	<ul style="list-style-type: none"> Latchbolt by key either side. Both grips always rigid. Auxiliary latch deadlocks latchbolt. <p>Note: This function does not allow free egress and can pose a life safety hazard in event of an emergency. Installation should be in accordance with approved codes only.</p>
		ML2040	Passage with Indicator	<ul style="list-style-type: none"> For doors with indicator that do not require locking Latchbolt retracted by grip either side at all times Throwing thumbturn on inside changes state of status indicator Rotating either grip returns indicator to previous state <p>Note: Only available with "V" series indicators. Indicator option code must be specified with this function</p>
 A01		ML2042 (F09)	Entrance or Public Restroom	<ul style="list-style-type: none"> Latchbolt by grip either side, unless outside grip is locked by key from inside. Latchbolt by key outside when outside grip is locked. Auxiliary latch deadlocks latchbolt. Inside grip always free.

 Indicator options available for both sectional and escutcheon trim.











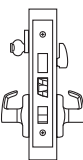



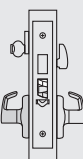



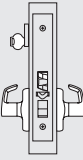

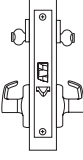
 Cylinder cam required.

 Indicates rigid grip.

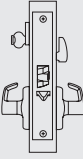
* When lever handles are furnished, both outside and inside are locked when deadbolt is projected.

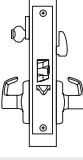
Functions

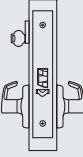
ML2000 Series











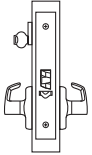

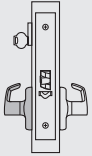
Outside	Inside	Function (ANSI No.)	Type	Function Description
   A01		ML2048 (F08/F10)	Entrance or Apartment	<ul style="list-style-type: none"> Latchbolt* by key outside or by grip either side, unless outside grip is locked by toggle-action stop. Deadbolt by key outside or by thumbturn grip inside. Inside grip free when deadbolt is retracted. Non-panic release. No simultaneous deadbolt and latch retraction. Note: Indicator shows deadbolt position only.
   A01		ML2049	Storeroom Deadbolt	<ul style="list-style-type: none"> Latchbolt and deadbolt by grip inside or by key outside. Inside grip simultaneously retracts deadbolt and latchbolt. Outside grip always rigid. Deadbolt thrown or retracted by key outside or thumbturn grip inside. Auxiliary latch deadlocks latchbolt. Inside grip always free. Note: Indicator shows deadbolt position only.
		ML2050	Half Dummy Trim	<ul style="list-style-type: none"> Grip acts as pull only; no operation.
   A01		ML2051 (F04)	Entrance or Office	<ul style="list-style-type: none"> Latchbolt by key when outside grip locked by toggle action stop. Latchbolt by grip either side, unless outside grip is locked by toggle-action stop. Auxiliary latch deadlocks latchbolt. Inside grip always free.
   A02	  A02	ML2052 (F32)	Classroom Intruder	<ul style="list-style-type: none"> Latchbolt by grip either side, unless outside grip is locked by key either side. Latchbolt by key when outside grip locked. Auxiliary latch deadlocks latchbolt. Inside grip always free. Outside grip remains locked unless unlocked by key either side. Note: Not available with indicator, specify ML2002.
   A02		ML2053	Entrance or Office	<ul style="list-style-type: none"> Latchbolt by grip either side, unless outside grip is locked or unlocked by key or thumbturn. Outside grip locked or unlocked by key or thumbturn. Latchbolt by key when outside grip locked. Auxiliary latch deadlocks latchbolt. Inside grip always free.
   A01		ML2054 (F04)	Entrance or Office	<ul style="list-style-type: none"> Latchbolt by grip either side, unless outside grip is locked. Outside grip locked or unlocked by thumbturn. Latchbolt by key when outside grip locked. Auxiliary latch deadlocks latchbolt. Inside grip always free. Multi-function capable, see page 10 for more info.
   A02		ML2055 (F05)	Classroom	<ul style="list-style-type: none"> Latchbolt by grip either side, unless outside grip is locked by key outside Latchbolt by key when outside grip locked. Auxiliary latch deadlocks latchbolt. Inside grip always free. Outside grip remains locked unless unlocked by key. Note: Not available with indicator, specify ML2003.

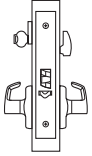
 Indicator options available for both sectional and escutcheon trim.

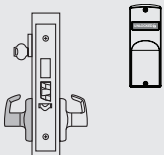

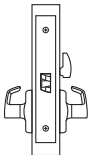
 Cylinder cam required.

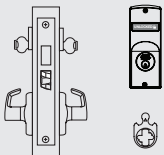
* When lever handles are furnished, both outside and inside are locked when deadbolt is projected.

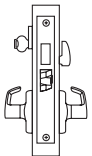
 Indicates rigid grip.

Outside	Inside	Function (ANSI No.)	Type	Function Description
		ML2056 (F06)	Classroom Holdback	<ul style="list-style-type: none"> Latchbolt by grip either side, unless outside grip is locked or unlocked by key. Latchbolt by key outside when outside grip is locked. Latchbolt can be held in a retracted position by key, or released by key. Auxiliary latch deadlocks latchbolt. Inside grip always free. <p>Note: Not Listed for use in fire rated applications.</p>
		ML2057 (F07)	Storeroom or Closet	<ul style="list-style-type: none"> Latchbolt by grip inside or by key outside. Outside grip always rigid. Auxiliary latch deadlocks latchbolt. Inside grip always free.
		ML2058	Entrance or Office Holdback	<ul style="list-style-type: none"> Latchbolt by grip either side, unless outside grip is locked. Outside grip locked or unlocked by key or thumbturn. Latchbolt retracted by key outside when outside grip is locked. Latchbolt can be held in a retracted position by key or thumbturn, or released by key or thumbturn. Auxiliary latch deadlocks latchbolt. Inside grip always free. <p>Note: Not Listed for use in fire rated applications.</p>
		ML2059	Security Storeroom or Closet	<ul style="list-style-type: none"> Latchbolt and deadbolt by grip inside or by key outside. Inside grip simultaneously retracts deadbolt & latchbolt. Outside grip always rigid. Auxiliary latch deadlocks latchbolt. Inside grip always free. <p>Note: Indicator shows deadbolt position only.</p>
		ML2060 (F22)	Privacy	<ul style="list-style-type: none"> Latchbolt by grip either side, except when outside grip is locked by thumbturn inside. Operating inside grip, closing door or operating emergency key outside unlocks outside grip. Inside grip always free. Not available with M19S or M19SN.
		ML2062 (F33)	Intruder Deadbolt	<ul style="list-style-type: none"> Latchbolt by grip either side, unless outside grip is locked by projection of deadbolt. Deadbolt thrown or retracted by key from either side. Inside grip simultaneously retracts latchbolt and deadbolt and unlocks outside grip. Inside grip always free.
		ML2065 (F13)	Dormitory or Entrance	<ul style="list-style-type: none"> Latchbolt by grip either side unless outside grip locked by projection of deadbolt. Deadbolt thrown or retracted by key outside or by thumbturn grip inside. Inside grip simultaneously retracts latchbolt and deadbolt and unlocks outside grip. Inside grip always free.











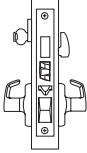

 Indicator options available for both sectional and escutcheon trim.

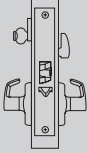
 Cylinder cam required.
 Indicates rigid grip.

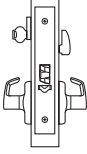
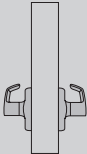
* When lever handles are furnished, both outside and inside are locked when deadbolt is projected.

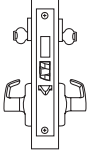
Functions

ML2000 Series

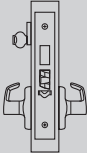
Outside	Inside	Function (ANSI No.)	Type	Function Description
  A01		ML2067 (F20)	Apartment or Dormitory	<ul style="list-style-type: none"> Latchbolt by grip either side, unless outside grip is locked by toggle-action stop or by projection of deadbolt. Deadbolt thrown or retracted by key outside or by thumbturn grip inside. Latchbolt and deadbolt retracted by key when outside grip is locked by toggle-action stop. Inside grip simultaneously retracts latchbolt and deadbolt; outside grip remains locked. Auxiliary latch deadlocks latchbolt. Outside grip unlocked by toggle-action stop. Note: Indicator shows deadbolt position only.
  A01		ML2068	Privacy or Apartment	<ul style="list-style-type: none"> Latchbolt by grip either side, unless outside grip is locked. Outside grip locked or unlocked by key or thumbturn. Operating inside grip, closing the door or using key unlocks outside grip. Inside grip always free. Auxiliary latch deadlocks latch.
  A02		ML2069 (F26)	Institutional Privacy	<ul style="list-style-type: none"> Latchbolt by grip either side, except when outside is locked by thumbturn inside. Operating inside grip or closing door unlocks outside grip. Key outside retracts latch at all times, even if thumbturn is held in locked position. Auxiliary latch deadlocks latchbolt. Not available with M19S, M19N, M19V, M19SN, M19VN.
		ML2070	Full Dummy Trim	<ul style="list-style-type: none"> Grips act as pulls only; no operation.
  A01	  A01	ML2072	Classroom Intruder	<ul style="list-style-type: none"> Latchbolt by grip from either side unless outside grip is locked by projection of deadbolt. Deadbolt thrown or retracted by key from either side. Inside grip simultaneously retracts latchbolt and deadbolt; outside grip remains locked. Key either side unlocks outside grip; outside grip remains locked unless unlocked by key. Auxiliary latch deadlocks latchbolt. Note: Indicator shows deadbolt position only.
  A01		ML2073	Classroom Security	<ul style="list-style-type: none"> Latchbolt by grip from either side unless outside grip is locked by projection of deadbolt. Deadbolt thrown or retracted by key . Inside grip simultaneously retracts latchbolt and deadbolt; outside grip remains locked. Key unlocks outside grip; outside grip remains locked unless unlocked by key. Auxiliary latch deadlocks latchbolt. Note: Indicator shows deadbolt position only.

 Indicator options available for both sectional and escutcheon trim.





 Cylinder cam required.

 Indicates rigid grip.

* When lever handles are furnished, both outside and inside are locked when deadbolt is projected.

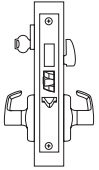
Functions

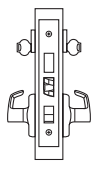
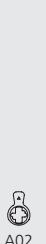
ML2000 Series

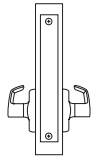
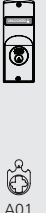
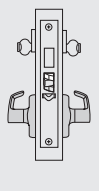
Outside	Inside	Function (ANSI No.)	Type	Function Description
		ML2075	Security Entrance or Office	<ul style="list-style-type: none"> Latchbolt by grip from either side unless outside grip is locked by projection of deadbolt. Deadbolt thrown or retracted by outside key or inside thumbturn. Inside grip simultaneously retracts latchbolt and deadbolt; outside grip remains locked. Key unlocks outside grip; outside grip remains locked unless unlocked by key. Auxiliary latch deadlocks latchbolt. Note: Indicator shows deadbolt position only.
		ML2080	Half Active Dummy Trim	<ul style="list-style-type: none"> Non-latching operation. Grip always active; acts as push or pull only. Note: Not available for doors over 2-1/4"
		ML2082 (F11)	Dormitory or Exit	<ul style="list-style-type: none"> Latchbolt by grip either side, unless outside grip is locked by toggle-action stop or by projection of deadbolt. Deadbolt thrown by key from either side. Deadbolt and latchbolt retracted by outside key when outside grip locked. Outside grip unlocked by toggle-action stop. Inside grip simultaneously retracts latchbolt and deadbolt; outside grip remains locked. Note: Indicator shows deadbolt position only.
		ML2087	Security Vestibule	<ul style="list-style-type: none"> Latchbolt by grip outside, unless outside grip is locked by key outside. Outside grip remains locked unless unlocked by key outside. Latchbolt by key outside when outside grip locked. Latchbolt by key inside. Inside grip always rigid. Auxiliary latch deadlocks latchbolt. Notes: <ul style="list-style-type: none"> - Handing must be specified. This function can only be field handed for door swing i.e. LH to LHR or RH to RHR. - Not available with L, R or V escutcheon trim. - This function does not allow free egress when inside locked and can pose a life safety hazard in event of an emergency. Installation should be in accordance with approved codes only.
		ML2090	Full Active Dummy Trim	<ul style="list-style-type: none"> Non-latching operation. Both grips always active; acts as push or pulls only.
		ML2092	Security Institution or Utility	<ul style="list-style-type: none"> Latchbolt by key either side. Deadbolt thrown and retracted by key either side. Auxiliary latch deadlocks latchbolt. Inside and outside grips remain locked at all times. Notes: <ul style="list-style-type: none"> - Indicator shows deadbolt position only. - This function does not allow free egress and can pose a life safety hazard in event of an emergency. Installation should be in accordance with approved codes only.

 Indicator options available for both sectional and escutcheon trim.

 Cylinder cam required.

 Indicates rigid grip.

* When lever handles are furnished, both outside and inside are locked when deadbolt is projected.

Multi-Function Configuration









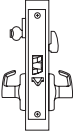

ML2000 Series

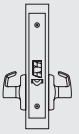
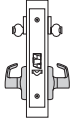
Multi-Function Capability for ML2000 Series

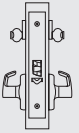
Corbin Russwin ML2000 Series mortise locks provide multi-function capability, allowing 12 functions to be configured using one lockbody.

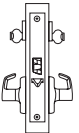

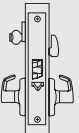



The current ML2054 entrance function (ANSI F04) uses a universal lockbody with the ability to reconfigure into 11 other functions without disassembling the lock case and using few additional parts. All new and existing ML2054 function mortise locks provide this flexibility.

By specifying the ML2054, stock ordering is easier and facility maintenance is simplified.

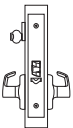
Illustration	Function (ANSI No.)	Type	Function Description	Instructions	Additional Part(s) Required
	ML2054 (F04)	Entrance or Office	<ul style="list-style-type: none"> Latchbolt by grip either side, unless outside grip is locked by thumbturn. Outside grip locked or unlocked by thumbturn. Latchbolt by key when outside grip locked. Auxiliary latch deadlocks latchbolt. Inside grip always free. 	<ul style="list-style-type: none"> Install thumbturn on inside. Install cylinder with A01 cam on outside. 	<ul style="list-style-type: none"> No additional parts required
	ML2010 (F01)	Passage or Closet	<ul style="list-style-type: none"> Latchbolt by grip either side. Both grips always free. <p>*Multi-Function lockbody comes with auxiliary latchbolt, does not affect the operation of the function</p>	<ul style="list-style-type: none"> Do not install thumbturn or cylinder. Remove red locking screw from lockbody. Install lock in unlocked condition. 	<ul style="list-style-type: none"> No additional parts required
	ML2032 (F30)	Institution or Utility	<ul style="list-style-type: none"> Latchbolt by key either side. Both grips always rigid. Auxiliary latch deadlocks latchbolt. <p>Note: This function does not allow free egress and can pose a life safety hazard in event of an emergency. Installation should be in accordance with approved codes only.</p>	<ul style="list-style-type: none"> Do not install thumbturn on inside. Install cylinders with A01 cam on both inside and outside. Add second red locking screw. Install lock in locked condition. 	<ul style="list-style-type: none"> Red locking screw (part number 684F067) Mortise cylinder with A01 cam 
	ML2042 (F09)	Entrance or Public Restroom	<ul style="list-style-type: none"> Latchbolt by grip either side, unless outside grip is locked by key from inside. Latchbolt by key outside when outside grip is locked. Auxiliary latch deadlocks latchbolt. Inside grip always free. 	<ul style="list-style-type: none"> Do not install thumbturn on inside. Install cylinders with A01 cam on outside and A02 cam on inside. 	<ul style="list-style-type: none"> Mortise cylinder with A02 cam 
	ML2052 (F32)	Classroom Intruder	<ul style="list-style-type: none"> Latchbolt by grip either side, unless outside grip is locked by key either side. Latchbolt by key when outside grip is locked. Auxiliary latch deadlocks latchbolt. Inside grip always free. Outside grip remains locked unless unlocked by key either side. 	<ul style="list-style-type: none"> Do not install thumbturn on inside. Change cam on cylinder to A02. Install cylinders with A02 cam on both inside and outside. 	<ul style="list-style-type: none"> A02 cam (part number 756F517) Mortise cylinder with A02 cam 
	ML2053	Entrance or Office	<ul style="list-style-type: none"> Latchbolt by grip either side, unless outside grip is unlocked by key or thumbturn. Outside grip remains locked unless unlocked by key or thumbturn. Latchbolt by key when outside grip locked. Auxiliary latch deadlocks latchbolt. Inside grip always free. 	<ul style="list-style-type: none"> Install thumbturn on inside. Change cam on cylinder to A02. Install cylinder on outside. 	<ul style="list-style-type: none"> A02 cam (part number 756F517) 

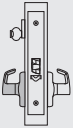
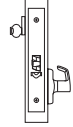
Multi-Function Configuration

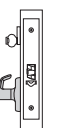
ML2000 Series

Illustration	Function (ANSI No.)	Type	Function Description	Instructions	Additional Part(s) Required
	ML2055 (F05)	Classroom	<ul style="list-style-type: none"> Latchbolt by grip either side, unless outside grip is locked by key outside. Latchbolt by key when outside grip locked. Auxiliary latch deadlocks latchbolt. Inside grip always free. Outside grip remains locked unless unlocked by key. 	<ul style="list-style-type: none"> Do not install thumbturn on inside. Change cam on cylinder to A02. Install cylinder on outside. 	<ul style="list-style-type: none"> A02 cam (part number 756F517) 
	ML2057 (F07)	Storeroom or Closet	<ul style="list-style-type: none"> Latchbolt by grip inside or by key outside. Outside grip always rigid. Auxiliary latch deadlocks latchbolt. Inside grip always free. 	<ul style="list-style-type: none"> Do not install thumbturn on inside. Install cylinder with A01 cam on outside. Install lock in locked condition. 	<ul style="list-style-type: none"> No additional parts required
	<i>Configured thru multi-function lock only</i>	Storeroom or Service	<ul style="list-style-type: none"> Latchbolt by grip inside or by key outside. Auxiliary latch deadlocks latchbolt. Inside grip always free. 	<ul style="list-style-type: none"> Do not install thumbturn on inside. Install cylinder with A01 cam on outside. Install 1/2 trim multi-function kit on outside. 	<ul style="list-style-type: none"> 1/2 trim multi-function kit (part number 853F958)*
	<i>Configured thru multi-function lock only (F31)</i>	Exit Latch	<ul style="list-style-type: none"> Latchbolt by grip inside. Auxiliary latch. Inside grip always free. 	<ul style="list-style-type: none"> Do not install thumbturn on inside. Do not install cylinders. Install 1/2 trim multi-function kit on outside. 	<ul style="list-style-type: none"> 1/2 trim multi-function kit (part number 853F958)*
	<i>Configured thru multi-function lock only</i>	Utility	<ul style="list-style-type: none"> Latchbolt by key outside. Outside grip always rigid. Auxiliary latch deadlocks latchbolt. <p>Note: This function does not allow free egress and can pose a life safety hazard in event of an emergency. Installation should be in accordance with approved codes only.</p>	<ul style="list-style-type: none"> Do not install thumbturn on inside. Install cylinder with A01 cam on outside. Install 1/2 trim multi-function kit on inside. Install inside lever on outside. 	<ul style="list-style-type: none"> 1/2 trim multi-function kit (part number 853F958)*
	<i>Configured thru multi-function lock only</i>	Closet	<ul style="list-style-type: none"> Latchbolt by grip outside, unless grip is locked by key outside. Latchbolt by key when outside grip locked. Auxiliary latch deadlocks latchbolt. Outside grip remains locked unless unlocked by key. <p>Note: This function does not allow free egress and can pose a life safety hazard in event of an emergency. Installation should be in accordance with approved codes only.</p>	<ul style="list-style-type: none"> Do not install thumbturn on inside. Install cylinder with A02 cam on the outside. Install 1/2 trim multi-function kit on inside. 	<ul style="list-style-type: none"> A02 cam (part number 756F517) 1/2 trim multi-function kit (part number 853F958)* 

*1/2 trim multi-function kit includes: M30 adapter plate (p/n 488F278), 2 retainer rings (p/n 427F078), 2 spacers (p/n 426F918), and 2 screws (p/n 814F808).

The information detailed pertains to sectional trim for standard 1-3/4" thick doors. For escutcheon trim and other applications, please contact our Technical Product Support specialists for information and details.

Features

ML20900 ECL & ML20600NAC Series

Features

Handing

Handed; quick reversible. The lockset can be re-handed without disassembling the lockcase.

Door Thickness

1-3/4" (44mm) standard. Optional door thicknesses available; see Quick Codes, page 80.

Backset

2-3/4" (70mm).

Lockcase

Heavy-gauge steel, 5-7/8" (149mm) x 4" (102mm) x 15/16" (24mm).

Front

Heavy gauge steel, 8" (203mm) x 1-1/4" (32mm) x 3/32" (2mm).
Accommodates flat doors and doors beveled 1/8" (3mm) in 2" (51mm).

Armored Front

Wrought brass, bronze or stainless steel attached by machine screws to lockcase front.

Latchbolt

2-piece mechanical anti-friction insert, 5/8" (16mm) x 1" (25mm) x 3/4" (19mm) throw.

Auxiliary Latchbolt

9/16" (14mm) effective throw and 3/8" (10mm) effective auxiliary latch deadlocking.

Hub

Standard knob/lever hub is steel, 5/16" (8mm)

Spacing

C. to c. knob/lever to cylinder: 3-5/8" (92mm)

C. to c. knob/lever to thumbturn: 2-7/16" (62mm).

Strike

Wrought brass, bronze or stainless steel ANSI straight lip standard, 4-7/8" (124mm) x 1-1/4" (32mm) x 1-1/8" (29mm) lip to center. Optional strikes, lip lengths and ANSI wrought strike box available; see Quick Codes, page 80.

Trim

Available with all ML2000 Series trim designs including the Vineyard™ Collection and the Muséo® Collection. See pages 20-62.

Cylinder

Brass, 6-pin, L4 keyway, 0-bitted standard. Optional cylinders available; see Quick Codes, page 72.

Keys

Two nickel silver standard.

Warranty

Ten-year limited warranty on ML2000 mortise lockset. Two-year limited warranty on electronic components.

Electrical Specifications (Fail Safe/Fail Secure)

12/24VDC @ 15mA Continuous
12/24VDC Peak current draw = .5A
(Maximum of 2 locks per 1A Power Supply)
Monitor Switch Rating: 2 amp @ 24VDC
Note: Operating voltage not to exceed +/- 10%.
See Quick Codes, page 82.

Environmental Specifications

Operating Temperature
-13°F (-25°C) to 151°F (66°C)
Operating Humidity
5% to 95% relative humidity
non-condensing

Monitor Options - ML2000 and ML20900 ECL Only

M91 - Latchbolt Monitor

Latchbolt monitoring is a SPDT switch which monitors the full extension of the main latch. Note: See page 82 for available functions.

M92 - Request to Exit Monitor

Request to Exit monitoring is a SPDT switch which monitors the activation of the trim. (Both levers activate switch) Note: See page 82 for available functions.

M105 - Security Monitor

Security Monitor is two switches in series that monitors lock status (locked or unlocked) and Auxiliary Latch position. Note: Monitoring options may only be ordered together as follows: M91xM92, M92xM105. Recommended for fail safe applications that require monitoring of the secure side when lock loses power. See page 82 for available functions.

Monitor Options – ML20600 NAC only

Internal End-of-Line Monitoring

Monitors the line from the access control panel to the lock, eliminating the risk of undetected tampering or damage.

PHR – Deadbolt Privacy Function

Engaging deadbolt disables remote access control unlocking (keypad or card reader) or scheduled unlock.

Certification/Compliance*

ANSI/BHMA

Certified A156.13 Series 1000, operational and security Grade 1. Meets A117.1 Accessibility Code.



UL/cUL

All locks listed for A label and lesser class doors, 4' x 10' single or 8' x 10' pair. Letter F and UL symbol on armored front indicate listing. Meets requirements of UL1034.

Any retrofit or other field modification to a fire rated opening can potentially impact the fire rating of the opening, and Corbin Russwin, Inc. makes no representations or warranties concerning what such impact may be in any specific situation. When retrofitting any portion of an existing fire-rated opening, or specifying and installing a new fire-rated opening, please consult with a code specialist or local code official (Authority Having Jurisdiction) to ensure compliance with all applicable codes and ratings.

California State Reference Code

(Formerly Title 19, California State Fire Marshal Standard)

All levers with returns comply; levers return to within 1/2" of door face.

*Any undated reference to a code or standard appearing in this catalog shall be interpreted as referring to the latest edition of that code or standard.

ML20900 ECL Series Electrified Mortise Lockset

Simplicity

Combine simplicity and access control with the Corbin Russwin ML20900 ECL series electrically controlled mortise lock. Utilizing the proven ML2000 Series mortise lockset with the patented quick reversible latchbolt, the ML20900 series provides remote locking and unlocking. The electrified lock can be installed in a standard mortise prep with slight modification by door manufacturer. The ML20900 ECL is ideal for use where increased security is necessary at all times, such as tenant space, pharmacies, computer rooms, and high security areas.

Security

In applications where increased security is required, look no further than the ML2000VR Vandal Resistant Trim. This cast stainless steel trim features tapered edges, double through bolts, torx-pin tamper resistant screws and the lever remains attached to the escutcheon when the spindle is broken.

Aesthetics

Access control doesn't mean a loss of visual appeal. The Vineyard™ Collection and the Muséo® Collection feature beautifully designed levers, perfect for high-profile applications where pleasing aesthetics is a must.

Additional Features

- Mechanical key override
- Patented Quick Reversible latchbolt (Patent pending and/or patent www.assaabloydss.com/patents.)

Featuring EcoFlex® Technology:

- Reduces energy consumption up to 96%, as certified by GreenCircle
 - Lower operating costs
 - Assists with load reduction in optimizing energy performance credit in LEED
 - Reduces number of power supplies required
- Field configurable to fail-safe or fail-secure
- Operates from 12-24VDC, offering greater flexibility in system design
- Innovative actuator design provides superior reliability
 - Higher performance and reduced maintenance
 - Ability to have longer cable runs without negatively impacting lock function
 - Reduces risk of voltage drops and eliminates inductive kickback
 - Lower total cost of ownership

Note: EcoFlex Technology is not available with master ring cylinders. Solenoid provided.

Typical Application

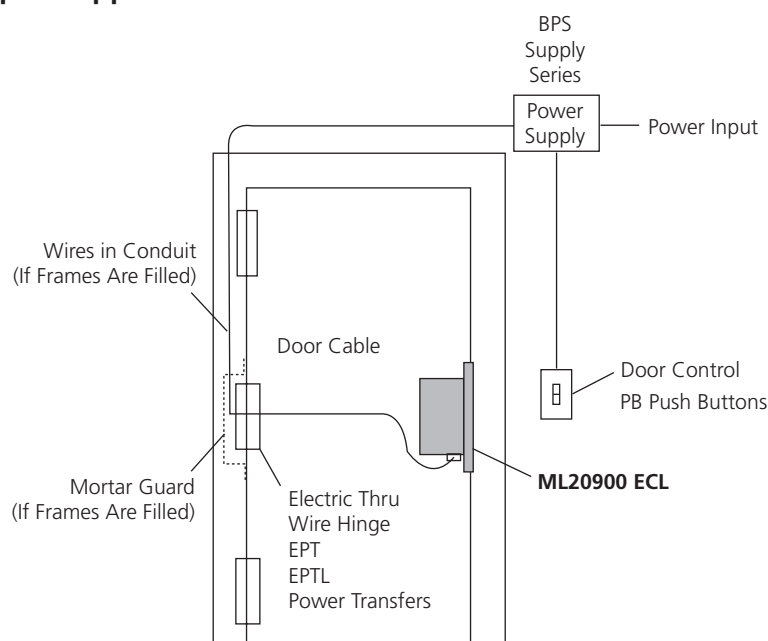

Typical System Components (For Reference Only)

ML20900 ECL Series

Tower Stairwell

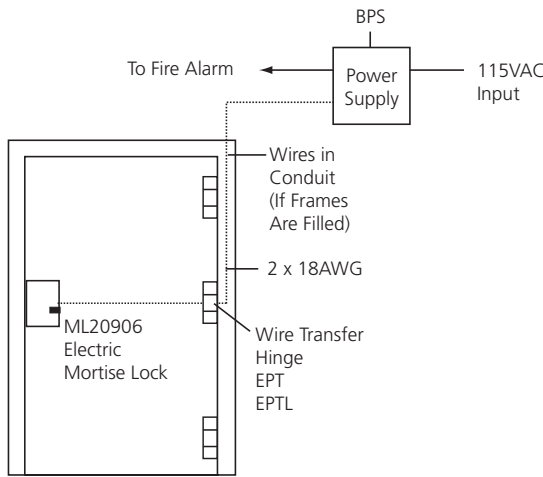

Access Control on Employee Entrance

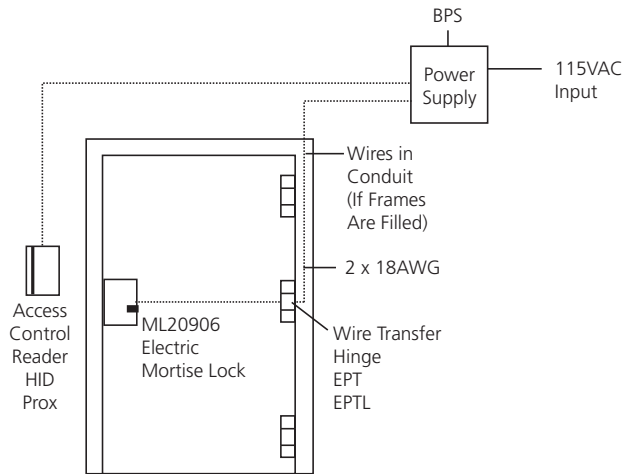

Operation:

Free egress at all times. Door is locked at all times preventing entry from the stairwell to a floor. Fire alarm activation will allow re-entry from the stairwell to the floor. Power failure will allow re-entry from the stairwell to the floor.

Operation:

Free egress at all times. Door is locked at all times preventing unauthorized entry. Authorized entry is permitted by presenting a valid user card.

Controlled Entry With Alarm

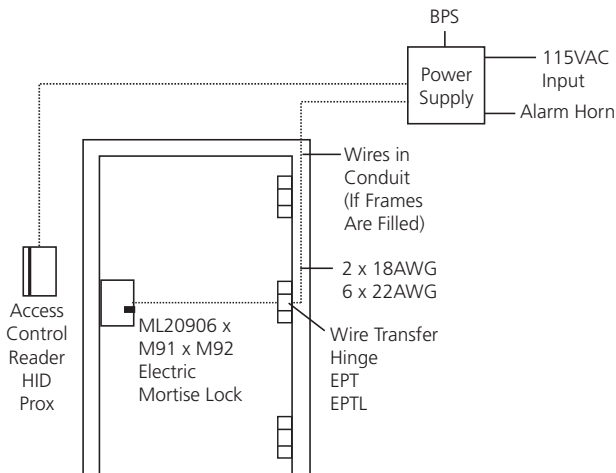

Operation:

Free egress at all times. User exits through the door which triggers the M92 switch which shunts the alarm. Door is locked at all times preventing unauthorized entry. Authorized entry is permitted by presenting a valid user card. Forced entry will trigger M91 switch and activate alarm. Alarm is deactivated by a valid user card.

ElectroLynx®, a system of universal Molex® plug-in connectors and standardized color-coded wiring, makes installing electrified doorway components a snap!



Lock Schematics

Power Leads

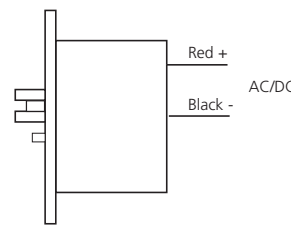

Power Leads x M92 (Request to Exit)

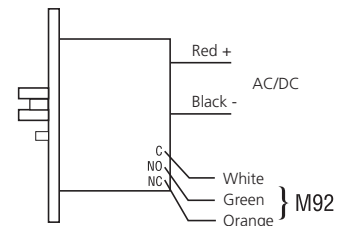

Power Leads x M91 (Latchbolt Monitor)

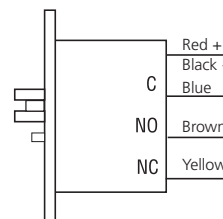



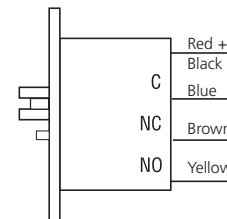





Power Leads x M105 (Security Monitor)

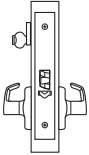
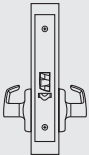

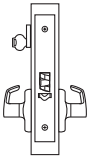
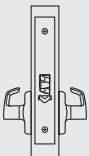
Consult factory for electrical system layouts, riser and wiring diagrams.

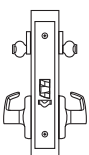
Fail Safe

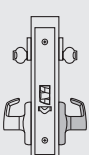
The following functions are unlocked when power is off and locked when the power is on.

Outside	Inside	Series/Function	Description
 		ML20906 x SAF	<ul style="list-style-type: none"> Latchbolt by grip either side, unless outside grip is locked by energizing lock. Latchbolt by key outside when lock is energized. Inside grip always free. Auxiliary latch deadlocks latchbolt.
		ML20907 x SAF	<ul style="list-style-type: none"> Latchbolt by grip either side, unless outside grip is locked by energizing lock. Inside grip always free. Auxiliary latch deadlocks latchbolt.
 		ML20914 x SAF	<ul style="list-style-type: none"> Latchbolt by grip either side, unless both grips are locked by energizing lock. Latchbolt by key outside when lock is energized. Auxiliary latch deadlocks latchbolt.
		ML20915 x SAF	<ul style="list-style-type: none"> Latchbolt by grip either side, unless both grips are locked by energizing lock. Auxiliary latch deadlocks latchbolt.
  		ML20932 x SAF	<ul style="list-style-type: none"> Latchbolt by grip either side, unless both grips are locked by energizing lock. Latchbolt by key inside or outside when lock is energized. Auxiliary latch deadlocks latchbolt.
  		ML20987 x SAF	<ul style="list-style-type: none"> Latchbolt by grip outside, unless outside grip is locked by energizing lock. Latchbolt by key both sides. Inside grip always rigid. Auxiliary latch deadlocks latchbolt. <p>Notes:</p> <ul style="list-style-type: none"> This function does not allow free egress and can pose a life safety hazard in the event of an emergency. Installation should be in accordance with approved codes only. Not available with L, R, or V escutcheon trim.







 Indicates rigid grip.

Functions

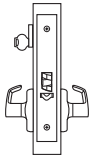
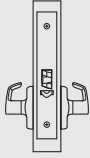
ML20900 ECL Series

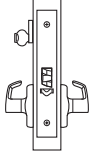
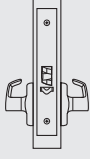
Fail Secure

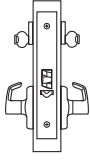
The following functions are locked when power is off and unlocked when the power is on.

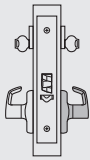
Outside	Inside	Series/Function	Description
 A01		ML20906 x SEC	<ul style="list-style-type: none"> Latchbolt by grip either side only when lock is energized. Outside grip locked when lock is not energized. Latchbolt by key outside when lock is not energized. Inside grip always free. Auxiliary latch deadlocks latchbolt.
		ML20907 x SEC	<ul style="list-style-type: none"> Latchbolt by grip either side only when lock is energized. Outside grip locked when lock is not energized. Inside grip always free. Auxiliary latch deadlocks latchbolt.
 A01		ML20914 x SEC	<ul style="list-style-type: none"> Latchbolt by grip either side only when lock is energized. Both grips locked when lock is not energized. Latchbolt by key outside when lock is not energized. Auxiliary latch deadlocks latchbolt.
		ML20915 x SEC	<ul style="list-style-type: none"> Latchbolt by grip either side only when lock is energized. Both grips locked when lock is not energized. Auxiliary latch deadlocks latchbolt.
 A01		ML20932 x SEC	<ul style="list-style-type: none"> Latchbolt by grip either side only when lock is energized. Both grips locked when lock is not energized. Latchbolt by key inside or outside when lock is not energized. Auxiliary latch deadlocks latchbolt
 A01		ML20987 x SEC	<ul style="list-style-type: none"> Latchbolt by grip outside when lock is energized. Outside grip locked when lock is not energized. Latchbolt by key both sides. Inside grip always rigid. Auxiliary latch deadlocks latchbolt. <p>Notes:</p> <ul style="list-style-type: none"> - This function does not allow free egress and can pose a life safety hazard in the event of an emergency. Installation should be in accordance with approved codes only. - Not available with L, R, or V escutcheon trim.

 Indicates rigid grip.

ML20600 NAC Series Electrified Mortise Lock with High Security Monitoring

The high security monitoring options of our industry-leading Integrated Wiegand locks are now available in a mortise lock with ElectroLynx® connectors that can be used as a stand-alone electrified lock or in conjunction with a wall reader. Every NAC lock is shipped with door position and request to exit monitoring installed. NAC locks ordered with deadbolt are supplied with deadbolt monitoring. (PHR options will replace deadbolt monitoring with deadbolt privacy)

High Security Monitoring Options

- **Internal End-of-Line Monitoring**

Integrated directly into the mortise lock, internal end-of-line resistors monitor the line from the access control panel to the lock. Typically, resistors are installed at the panel or above the door, creating vulnerability between the resistors and the locks. Incorporating resistors within the lock eliminates any risk of undetected tampering or damage, while also reducing installation costs, simplifying specifications, and offering the assurance of a factory installed and tested product.

Select a compatible resistor configuration and add the appropriate quick code to the beginning of your order string:

- **R01:** Mercury and Lenel compatible 1KΩ/2KΩ resistance supervision
- **R03:** Software House compatible 1KΩ/2KΩ resistance supervision
- **R04:** AMAG compatible 4-state supervision

- **Deadbolt Privacy Function (PHR)**

- Engaging the deadbolt disables remote access control unlocking (keypad or card reader) or scheduled unlock.
- Ideal for personal privacy areas, such as nursing rooms, on-call doctors' rooms, restrooms, and shower areas
- To order, add the PHR to the options of your order string available with SEC deadbolt functions only (ML20608 x SEC or ML20609 x SEC)

See how to order examples page 77.



Featuring EcoFlex® Technology:

- Reduces energy consumption up to 96% as certified by GreenCircle
 - Lower operating costs
 - Assists with load reduction in optimizing energy performance credit in LEED
 - Reduces number of power supplies required
- Field configurable to fail-safe or fail-secure
- Operates from 12-24VDC, offering greater flexibility in system design
- Innovative actuator design provides superior reliability
 - Higher performance and reduced maintenance
 - Ability to have longer cable runs without negatively impacting lock function
 - Reduces risk of voltage drops and eliminates inductive kickback
 - Lower total cost of ownership

Functions



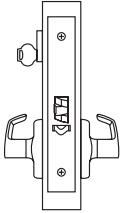
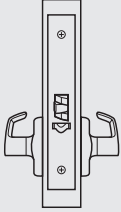

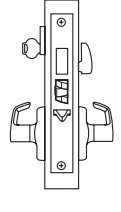
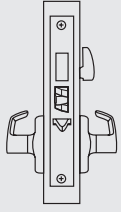
ML20600 NAC Series

Fail Safe

Outside	Inside	Series/Function	Type	Function Description
 A01		ML20606 x NAC x SAF Fail Safe With Key Override No Deadbolt	Entry	<ul style="list-style-type: none"> • Fail Safe - Power off unlocks outside trim. • Deadlocking latch. • Latch retracted by inside lever at all times. • Outside lever rigid except when lock is not energized. • Key outside retracts latch. • Request to exit and secure door position monitor are standard.
		ML20607 x NAC x SAF Fail Safe No Key Override No Deadbolt	Entry	<ul style="list-style-type: none"> • Fail Safe - Power off unlocks outside trim. • Deadlocking latch. • Latch retracted by inside lever at all times. • Outside lever rigid except when lock is not energized. • Request to exit and secure door position monitor are standard.
 A01		ML20608 x NAC x SAF Fail Safe With Key Override With Deadbolt	Entry With Deadbolt	<ul style="list-style-type: none"> • Fail Safe - Power off unlocks outside trim. • Deadlocking latch. • Latch and deadbolt retracted by inside lever and deadbolt at all times. • Outside lever rigid except when lock is not energized. • Key outside projects or retracts deadbolt and retracts latch. • Turnpiece inside extends and retracts deadbolt. • Request to exit and secure door position monitor are standard.
		ML20609 x NAC x SAF Fail Safe No Key Override With Deadbolt	Entry With Deadbolt	<ul style="list-style-type: none"> • Fail Safe - Power off unlocks outside trim. • Deadlocking latch. • Latch and deadbolt retracted by inside lever at all times. • Outside lever rigid except when lock is not energized. • Turnpiece inside extends and retracts deadbolt. • Request to exit and secure door position monitor are standard.

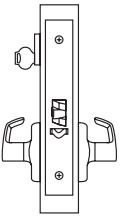
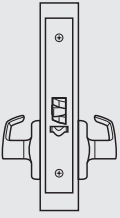
 Cylinder cam required.

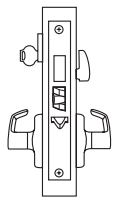
Fail Secure

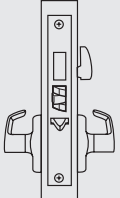
Outside	Inside	Series/Function	Type	Function Description
		ML20606 x NAC x SEC Fail Secure With Key Override No Deadbolt	Entry	<ul style="list-style-type: none"> • Fail Secure - Power off, trim outside is locked. • Deadlocking latch. • Latch retracted by inside lever at all times. • Outside lever rigid except when lock is energized. • Key outside retracts latch. • Request to exit and secure door position monitor are standard.
		ML20607 x NAC x SEC Fail Secure No Key Override No Deadbolt	Entry	<ul style="list-style-type: none"> • Fail Secure - Power off, trim outside is locked. • Deadlocking latch. • Latch retracted by inside lever at all times. • Outside lever rigid except when lock is energized. • Request to exit and secure door position monitor are standard.
 		ML20608 x NAC x SEC Fail Secure With Key Override With Deadbolt	Entry With Deadbolt	<ul style="list-style-type: none"> • Fail Secure - Power off, trim outside is locked. • Deadlocking latch. • Latch and deadbolt retracted by inside lever and deadbolt at all times. • Outside lever rigid except when lock is energized. • Key outside projects or retracts deadbolt and retracts latch. • Turnpiece inside extends and retracts deadbolt. • Request to exit and secure door position monitor are standard. • Indicator shows deadbolt position only. <p>Note: Indicator only available when used with PHR option.</p>
		ML20609 x NAC x SEC Fail Secure No Key Override With Deadbolt	Entry With Deadbolt	<ul style="list-style-type: none"> • Fail Secure - Power off, trim outside is locked. • Deadlocking latch. • Latch and deadbolt retracted by inside lever at all times. • Outside lever rigid except when lock is energized. • Turnpiece inside extends and retracts deadbolt. • Request to exit and secure door position monitor are standard. • Indicator shows deadbolt position only. <p>Note: Indicator only available when used with PHR option.</p>

 Indicator options available for both sectional and escutcheon trim.

 Cylinder cam required.

Trim Designs

ML2000, ML20900 ECL and ML20600 NAC Series



Lustra

Complies with codes requiring lever to return to within 1/2" (13mm) of door face. Brass, bronze or stainless steel.



LWA

Lever: Wrought
Rose: Wrought

LWB

Lever: Wrought
Rose: Cast



LSA

Lever: Cast
Rose: Wrought

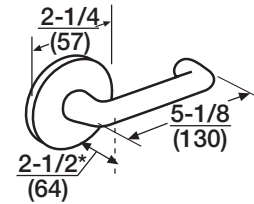

LSB

Lever: Cast
Rose: Cast

LWF

Lever: Wrought
Rose: Cast



LSF

Lever: Cast
Rose: Cast

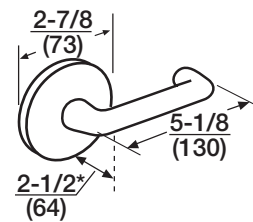

Dimensions:

$\frac{\text{inches}}{\text{millimeters}}$

*Dimension from face of door, not surface of rose or escutcheon.

Trim Designs

ML2000, ML20900 ECL and ML20600 NAC Series



LWM

Lever: Wrought
Escutcheon: Wrought
Optional: Plug only to show; master ring

LSM

Lever: Cast
Escutcheon: Wrought
Optional: Plug only to show; master ring

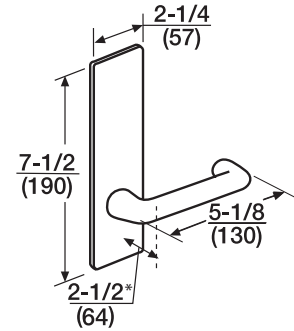

LWN

Lever: Wrought
Escutcheon: Wrought

LSN

Lever: Cast
Escutcheon: Wrought

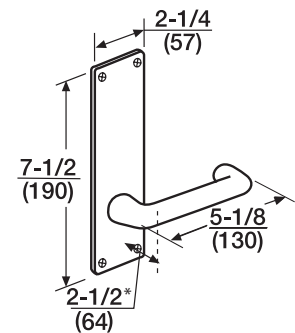

LWP

Lever: Wrought
Escutcheon: Wrought

LSP

Lever: Cast
Escutcheon: Wrought
Note: P escutcheon is not compatible with ML20900 ECL or ML20600 NAC mortise locks

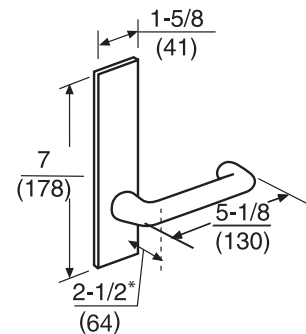

LWR

Lever: Wrought
Escutcheon: Solid stainless steel; forged brass
Optional: Plug only to show
Door thickness: 1-3/8" (35mm), 1-3/4" (44mm), 2-1/4" (57mm)

LSR

Lever: Cast
Escutcheon: Solid stainless steel, forged brass
Optional: Plug only to show
Door thickness: 1-3/8" (35mm), 1-3/4" (44mm), 2-1/4" (57mm)
Note: R escutcheon is not available for functions ML2087 or ML20987

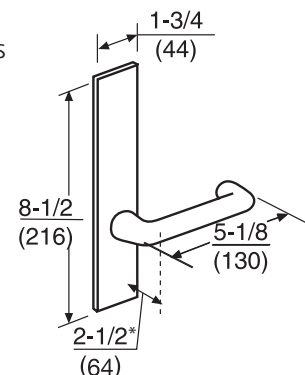

*Dimension from face of door, not surface of rose or escutcheon.

Trim Designs

ML2000, ML20900 ECL and ML20600 NAC Series



Regis

Brass, bronze or stainless steel



RWA

Lever: Wrought
Rose: Wrought

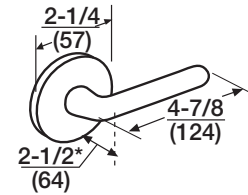

RWB

Lever: Wrought
Rose: Cast

RSA

Lever: Cast
Rose: Wrought

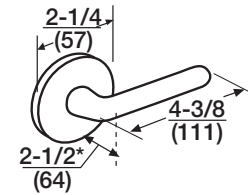

RSB

Lever: Cast
Rose: Cast



RWF

Lever: Wrought
Rose: Cast

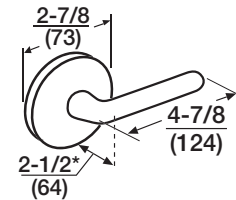

RSF

Lever: Cast
Rose: Cast

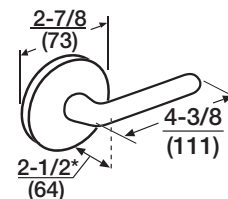

*Dimension from face of door, not surface of rose or escutcheon.

Trim Designs

ML2000, ML20900 ECL and ML20600 NAC Series



RWM

Lever: Wrought
Escutcheon: Wrought
Optional: Plug only to show; master ring

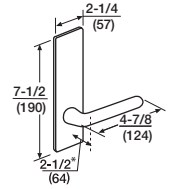

RSM

Lever: Cast
Escutcheon: Wrought
Optional: Plug only to show; master ring

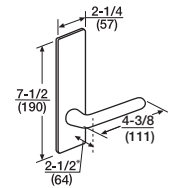

RWN

Lever: Wrought
Escutcheon: Wrought

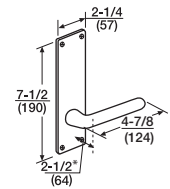

RSN

Lever: Cast
Escutcheon: Wrought

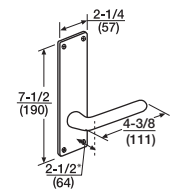

RWP

Lever: Wrought
Escutcheon: Wrought

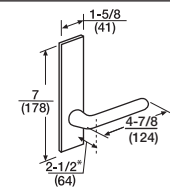

RSP

Lever: Cast
Escutcheon: Wrought
Note: P escutcheon is not compatible with ML20900 ECL or ML20600 NAC mortise locks

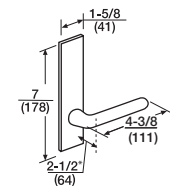

RWR

Lever: Wrought
Escutcheon: Solid stainless steel; forged brass
Optional: Plug only to show
Door thickness: 1-3/8" (35mm), 1-3/4" (44mm), 2-1/4" (57mm)

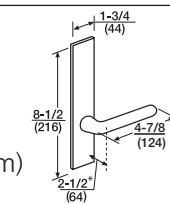

RSR

Lever: Cast
Escutcheon: Solid stainless steel; forged brass
Optional: Plug only to show
Door thickness: 1-3/8" (35mm), 1-3/4" (44mm), 2-1/4" (57mm)
Note: R escutcheon is not available for functions ML2087 or ML20987

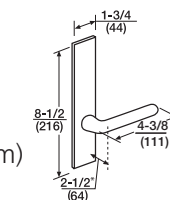

*Dimension from face of door, not surface of rose or escutcheon.

Trim Designs

ML2000, ML20900 ECL and ML20600 NAC Series



Citation

- Brass, bronze or stainless steel
- Laser engraving option
(See Custom Laser Engraving brochure)



CSA

Lever: Cast
Rose: Wrought

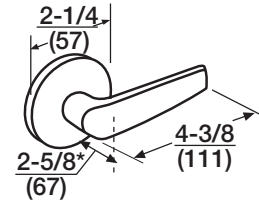

CSB

Lever: Cast
Rose: Cast



CSF

Lever: Cast
Rose: Cast

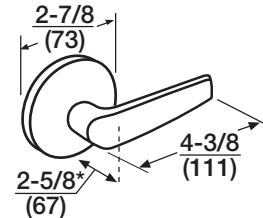

*Dimension from face of door, not surface of rose or escutcheon.

Trim Designs

ML2000, ML20900 ECL and ML20600 NAC Series



CSM

- Lever: Cast
Escutcheon: Wrought
Optional:
- Plug only to show; master ring
 - Laser engraving on lever or escutcheon

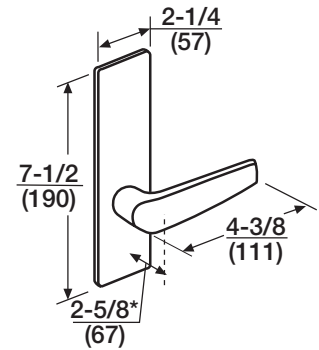

CSN

- Lever: Cast
Escutcheon: Wrought
Optional: Laser engraving on lever

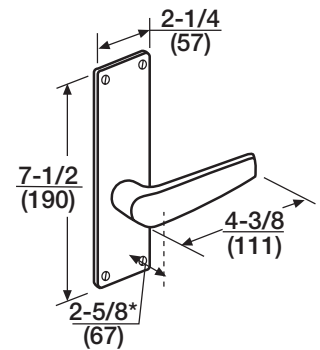

CSP

- Lever: Cast
Escutcheon: Wrought
Optional: Laser engraving on lever
- Note: P escutcheon is not compatible with ML20900 ECL or ML20600 NAC mortise locks

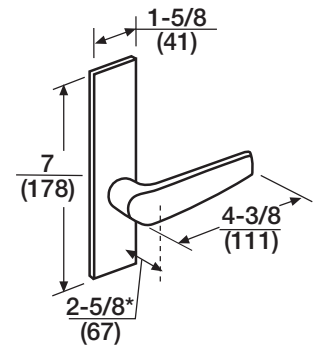

CSR

- Lever: Cast
Escutcheon: Solid stainless steel; forged brass
Optional:
- Plug only to show
 - Laser engraving on lever
- Door thickness: 1-3/8" (35mm), 1-3/4" (44mm), 2-1/4" (57mm)
Note: R escutcheon is not available for functions ML2087 or ML20987

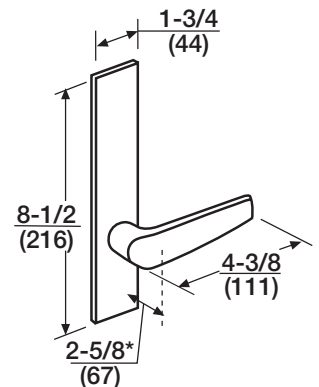

*Dimension from face of door, not surface of rose or escutcheon.

Copyright © 2001-2021, ASSA ABLOY Access and Egress Hardware Group, Inc. All rights reserved. Reproduction in whole or in part without the express written permission of ASSA ABLOY Access and Egress Hardware Group, Inc. is prohibited. Patent pending and/or patent www.assaabloydss.com/patents.

Trim Designs

ML2000, ML20900 ECL and ML20600 NAC Series



Newport

- Complies with codes requiring lever to return to within 1/2" (13mm) of door face.
- Brass, bronze or stainless steel
- Laser engraving option
(See Custom Laser Engraving brochure)



NSA

Lever: Cast
Rose: Wrought

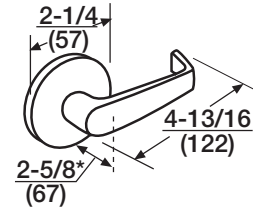

NSF

Lever: Cast
Rose: Cast

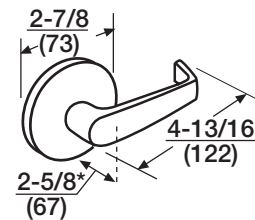

*Dimension from face of door, not surface of rose or escutcheon.

Trim Designs

ML2000, ML20900 ECL and ML20600 NAC Series



NSM

Lever: Cast

Escutcheon: Wrought

Optional:

- Plug only to show; master ring
- Laser engraving on lever or escutcheon

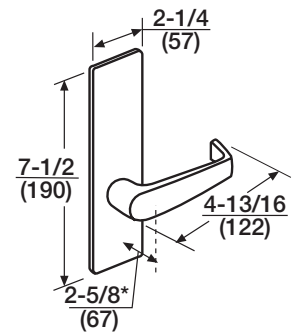

NSN

Lever: Cast

Escutcheon: Wrought

Optional: Laser engraving on lever

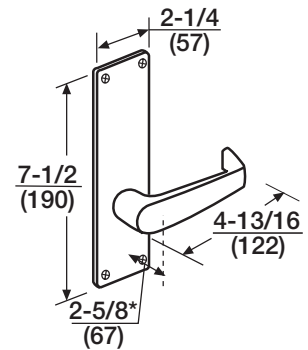

NSP

Lever: Cast

Escutcheon: Wrought

Optional: Laser engraving on lever

Note: P escutcheon is not compatible with ML20900 ECL or ML20600 NAC mortise locks

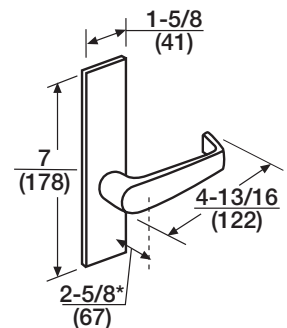

NSR

Lever: Cast

Escutcheon: Solid stainless steel;
forged brass

Optional:

- Plug only to show
- Laser engraving on lever

Door thickness: 1-3/8" (35mm),
1-3/4" (44mm), 2-1/4" (57mm)

Note: R escutcheon is not available for functions
ML2087 or ML20987

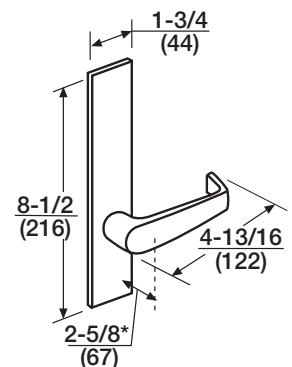

*Dimension from face of door, not surface of rose or escutcheon.

Trim Designs

ML2000, ML20900 ECL and ML20600 NAC Series



Armstrong

- Brass, bronze or stainless steel
- Laser engraving option
(See Custom Laser Engraving brochure)



ASA

Lever: Cast
Rose: Wrought

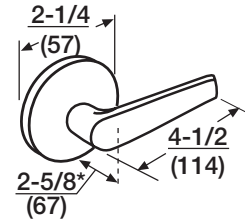

ASB

Lever: Cast
Rose: Cast



ASF

Lever: Cast
Rose: Cast

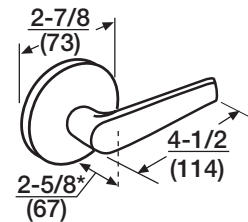

*Dimension from face of door, not surface of rose or escutcheon.

Trim Designs

ML2000, ML20900 ECL and ML20600 NAC Series



ASM

Lever: Cast

Escutcheon: Wrought

Optional:

- Plug only to show; master ring
- Laser engraving on lever or escutcheon

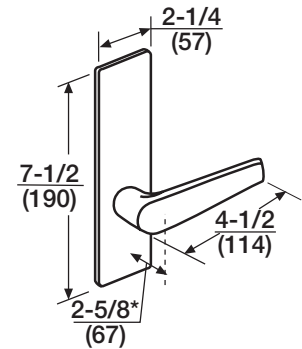

ASN

Lever: Cast

Escutcheon: Wrought

Optional: Laser engraving on lever

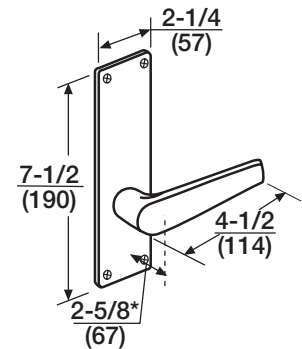

ASP

Lever: Cast

Escutcheon: Wrought

Optional: Laser engraving on lever

Note: P escutcheon is not compatible with ML20900 ECL or ML20600 NAC mortise locks

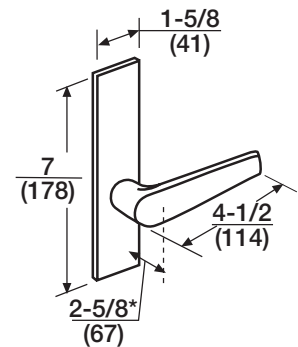

ASR

Lever: Cast

Escutcheon: Solid stainless steel; forged brass

Optional:

- Plug only to show
 - Laser engraving on lever
- Door thickness: 1-3/8" (35mm), 1-3/4" (44mm), 2-1/4" (57mm)
- Note: R escutcheon is not available for functions ML2087 or ML20987

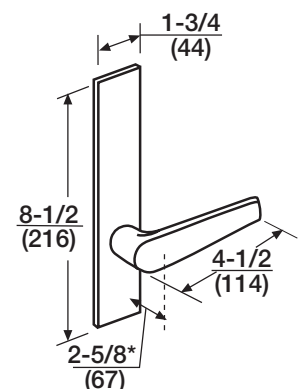

*Dimension from face of door, not surface of rose or escutcheon.

Trim Designs

ML2000, ML20900 ECL and ML20600 NAC Series



Dirke

Brass, bronze or stainless steel

- Not reversible
- Handed levers



DSA

Lever: Cast
Rose: Wrought
Specify hand

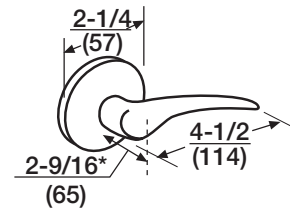

DSB

Lever: Cast
Rose: Cast
Specify hand

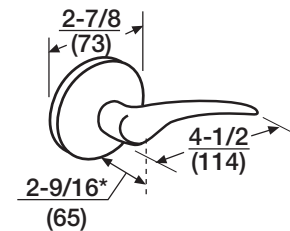

DSF

Lever: Cast
Rose: Cast
Specify hand

*Dimension from face of door, not surface of rose or escutcheon.

Trim Designs

ML2000, ML20900 ECL and ML20600 NAC Series



DSM

Lever: Cast
Escutcheon: Wrought
Optional: Plug only to show; master ring
Specify hand

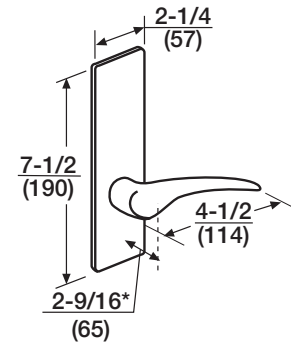

DSN

Lever: Cast
Escutcheon: Wrought
Specify hand

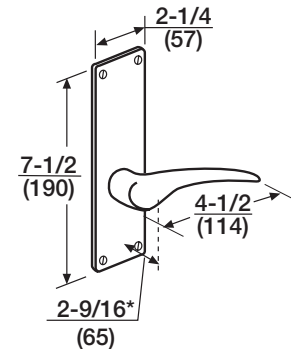

DSP

Lever: Cast
Escutcheon: Wrought
Specify hand

Note: P escutcheon is not compatible with ML20900 ECL or ML20600 NAC mortise locks

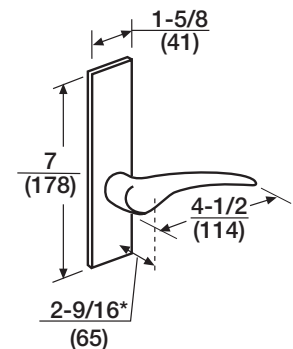

DSR

Lever: Cast
Escutcheon: Solid stainless steel;
forged brass

Optional: Plug only to show
Door thickness: 1-3/8" (35mm),
1-3/4" (44mm), 2-1/4" (57mm)

Specify hand

Note: R escutcheon is not available for functions ML2087 or ML20987

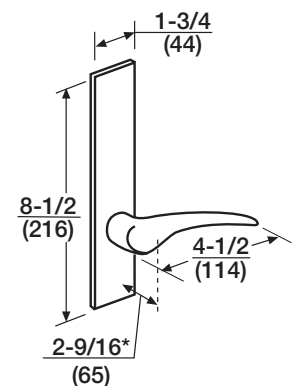

Trim Designs

ML2000, ML20900 ECL and ML20600 NAC Series



Essex

Complies with codes requiring lever to return to within 1/2" (13mm) of door face.
Brass, bronze or stainless steel



ESA

Lever: Cast
Rose: Wrought

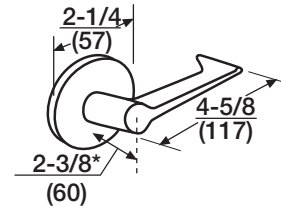

ESB

Lever: Cast
Rose: Cast



ESF

Lever: Cast
Rose: Cast

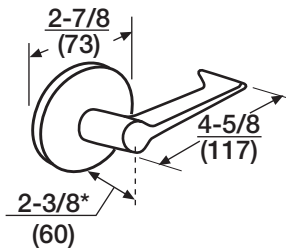

*Dimension from face of door, not surface of rose or escutcheon.

Trim Designs

ML2000, ML20900 ECL and ML20600 NAC Series



ESM

Lever: Cast
Escutcheon: Wrought
Optional: Plug only to show; master ring

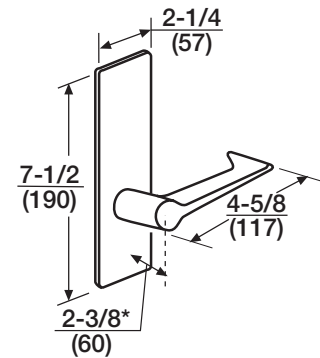

ESN

Lever: Cast
Escutcheon: Wrought

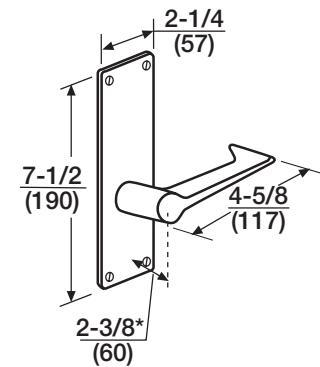

ESP

Lever: Cast
Escutcheon: Wrought
Note: P escutcheon is not compatible with ML20900 ECL or ML20600 NAC mortise locks

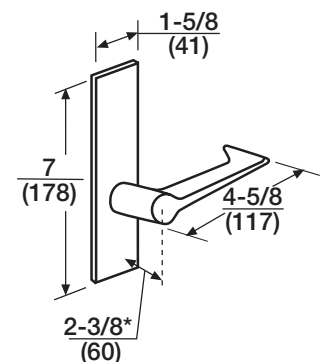

ESR

Lever: Cast
Escutcheon: Solid stainless steel; forged brass
Optional: Plug only to show
Door thickness: 1-3/8" (35mm), 1-3/4" (44mm), 2-1/4" (57mm)
Note: R escutcheon is not available for functions ML2087 or ML20987

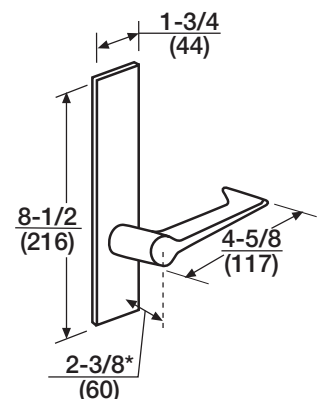

*Dimension from face of door, not surface of rose or escutcheon.

Trim Designs

ML2000, ML20900 ECL and ML20600 NAC Series



Princeton

- Complies with codes requiring lever to return to within 1/2" (13mm) of door face.
- Brass, bronze or stainless steel
- Laser engraving option
(See Custom Laser Engraving brochure)



PSA

Lever: Cast
Rose: Wrought

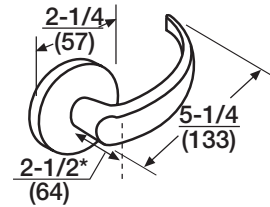

PSF

Lever: Cast
Rose: Cast

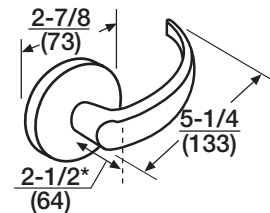

*Dimension from face of door, not surface of rose or escutcheon.

Trim Designs

ML2000, ML20900 ECL and ML20600 NAC Series



PSM

- Lever: Cast
Escutcheon: Wrought
Optional:
- Plug only to show; master ring
 - Laser engraving on lever or escutcheon

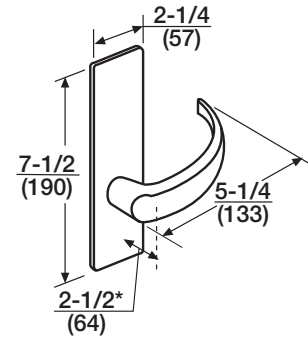

PSN

- Lever: Cast
Escutcheon: Wrought
Optional: Laser engraving on lever

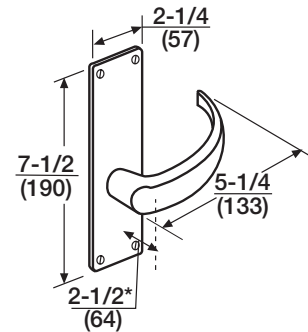

PSP

- Lever: Cast
Escutcheon: Wrought
Optional: Laser engraving on lever
- Note: P escutcheon is not compatible with ML20900 ECL or ML20600 NAC mortise locks

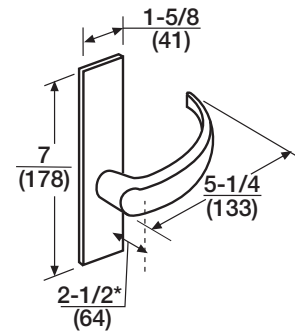

PSR

- Lever: Cast
Escutcheon: Solid stainless steel; forged brass
Optional:
- Plug only to show
 - Laser engraving on lever
- Door thickness: 1-3/8" (35mm), 1-3/4" (44mm), 2-1/4" (57mm)
- Note: R escutcheon is not available for functions ML2087 or ML20987

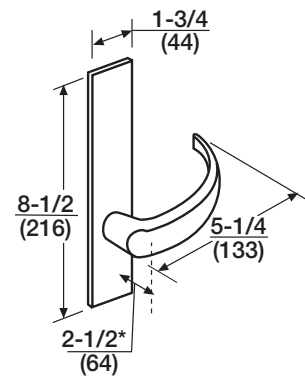

*Dimension from face of door, not surface of rose or escutcheon.

Trim Designs

ML2000, ML20900 ECL and ML20600 NAC Series



Global Zinc



GZA

Knob: Solid Cast
Rose: Wrought

GZB

Knob: Solid Cast
Rose: Cast

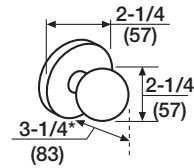

GZF

Knob: Solid Cast
Rose: Cast

GZH

Knob: Solid Cast
Rose: Wrought

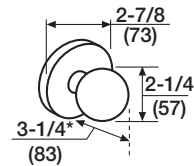

*Dimension from face of door, not surface of rose or escutcheon.

Trim Designs

ML2000, ML20900 ECL and ML20600 NAC Series



GZM¹
Knob: Solid Cast
Escutcheon: Wrought

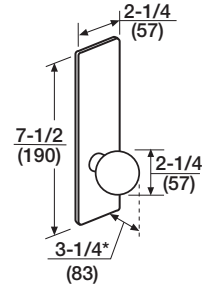

GZN
Knob: Solid Cast
Escutcheon: Wrought

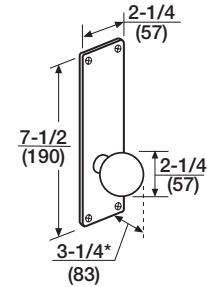

GZP
Knob: Solid Cast
Escutcheon: Wrought

Note: P escutcheon is not compatible with ML20900 ECL or ML20600 NAC mortise locks

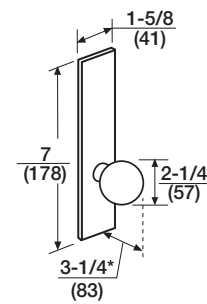

GZR^{1,2}
Knob: Solid Cast
Escutcheon: Solid stainless steel; forged brass

Note: R escutcheon is not available for functions ML2087 or ML20987

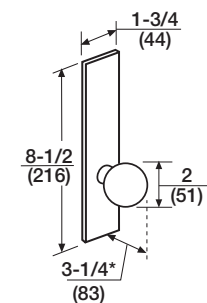

1. Optional: Plug only to show; master ring
2. Door thickness: 1-3/8" (35mm), 1-3/4" (44mm), 2-1/4" (57mm)
*Dimension from face of door, not surface of rose or escutcheon.

Trim Designs

ML2000, ML20900 ECL and ML20600 NAC Series

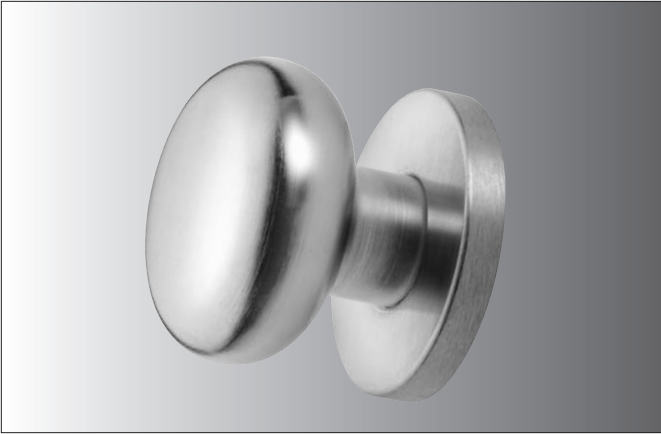

Yankee

Zinc



YZA

Knob: Solid Cast
Rose: Wrought

YZB

Knob: Solid Cast
Rose: Cast

YZF

Knob: Solid Cast
Rose: Cast

YZH

Knob: Solid Cast
Rose: Wrought

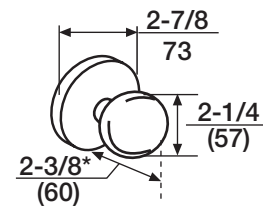
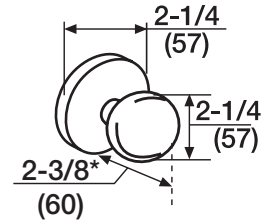

YZM

Knob: Solid Cast
Escutcheon: Wrought
Optional: Plug only to show; master ring

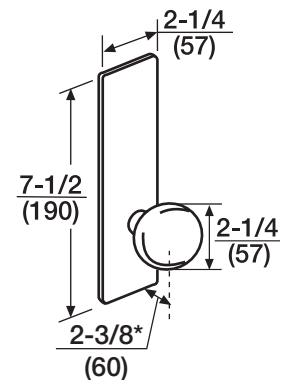

*Dimension from face of door, not surface of rose or escutcheon.

Trim Designs

ML2000, ML20900 ECL and ML20600 NAC Series



YZN

Knob: Solid Cast
Rose: Wrought

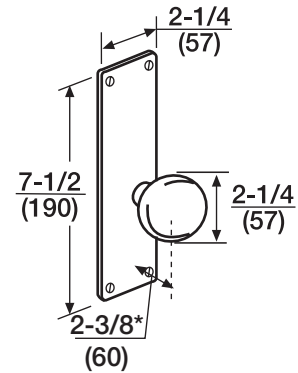

YZP

Knob: Solid Cast
Escutcheon: Wrought

Note: P escutcheon is not compatible with ML20900 ECL or ML20600 NAC mortise locks

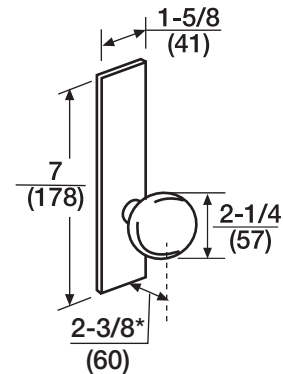

YZR

Knob: Solid Cast
Escutcheon: Solid stainless steel or forged brass

Optional: Plug only to show
Door thickness: 1-3/8" (35mm), 1-3/4" (44mm), 2-1/4" (57mm)

Note: R escutcheon is not available for functions ML2087 or ML20987

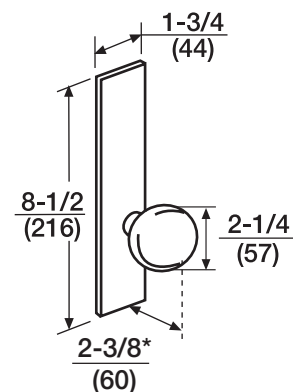

*Dimension from face of door, not surface of rose or escutcheon.

Muséo® Trim Designs

ML2000, ML20900 ECL and ML20600 NAC Series



Georgia

Timeless elegance in forms inspired by the natural world.

Laser Engraving offered on 102, 103, 124 and 125. See Custom Laser Engraving brochure for details.



102
Lever: Cast
Non-Handed lever

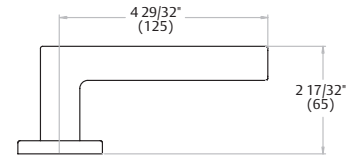

103
Lever: Cast
Non-Handed lever

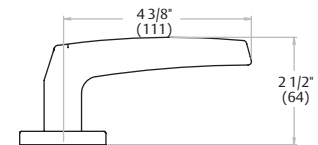

104^{2,4}
Lever: Cast
Non-Handed lever

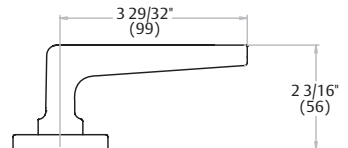

124¹
Lever: Cast
Non-Handed lever

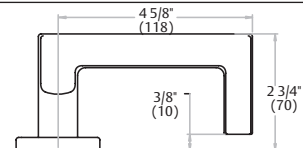

125¹
Lever: Cast
Non-Handed lever

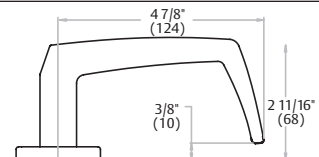

1. Complies with codes requiring lever to return to within 1/2" (13mm) of door face.
2. Not available with Inspire™ roseless trim.
3. Contact factory for current lead times.
4. Not available in 629 or 630 finish

Muséo® Trim Designs

ML2000, ML20900 ECL and ML20600 NAC Series

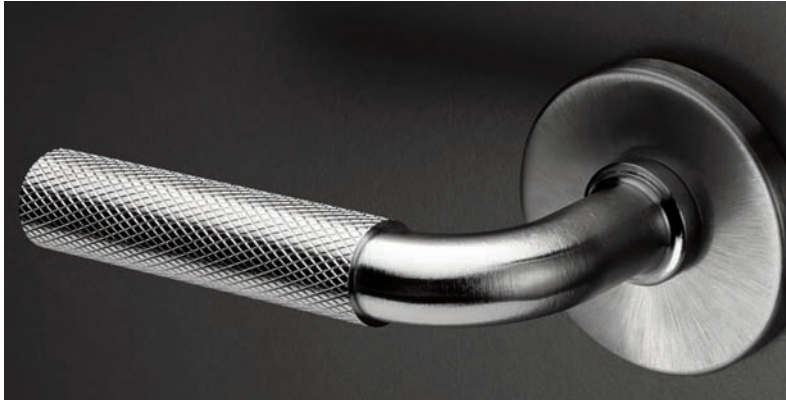

Laszlo²

Fine art meets function through crafted lines and flowing curves



147
Lever: Cast
Non-Handed lever

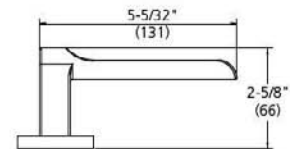

148¹
Lever: Cast
Handed - Specify hand
Non-Reversible

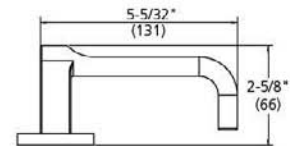

149
Lever: Cast
Non-Handed lever

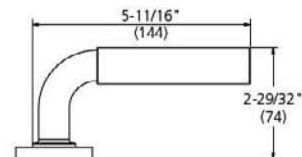

150
Lever: Cast
Non-Handed lever

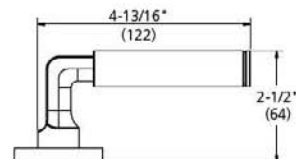

1. Complies with codes requiring lever to return to within 1/2" (13mm) of door face.
2. Not available with Inspire™ roseless trim.

Muséo® Trim Designs

ML2000, ML20900 ECL and ML20600 NAC Series



Jackson

Intuitive shapes, moving with the energetic rhythm of modern life.



105^{3,4}
Lever: Cast
Non-handed lever

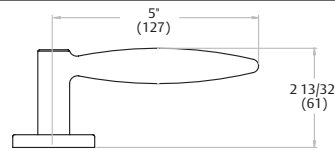

117⁴
Lever: Cast
Non-Handed lever

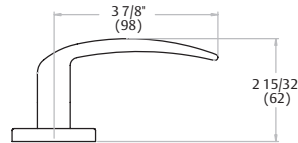

119⁴
Lever: Cast
Handed - Specify hand
Non-Reversible

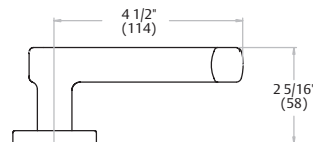

121^{2,4}
Lever: Cast
Handed - Specify hand
Non-Reversible

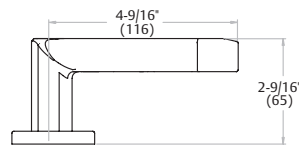

126^{1,4}
Lever: Cast
Handed - Specify hand
Non-Reversible

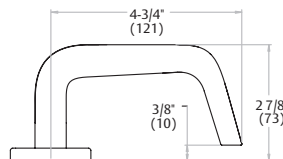

127^{1,4}
Lever: Cast
Handed - Specify hand
Non-Reversible

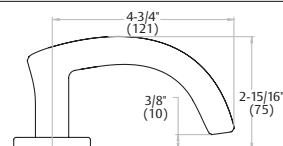

1. Complies with codes requiring lever to return to within 1/2" (13mm) of door face.
2. Not available with Inspire™ roseless trim.
3. Contact factory for current lead times.
4. Not available in 629 or 630 finish

Muséo® Trim Designs

ML2000, ML20900 ECL and ML20600 NAC Series



Salvador

Dreamlike beauty manifested in solid, familiar forms.



106
Lever: Cast
Non-handed lever

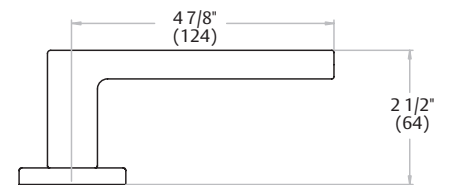

107
Lever: Cast
Non-handed lever

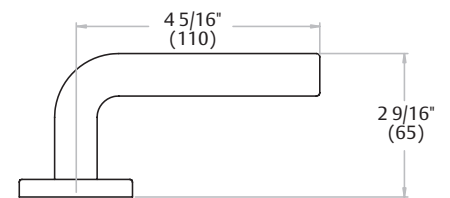

108
Lever: Cast
Non-handed lever

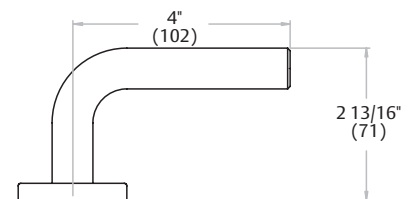

109¹
Lever: Cast
Non-Handed lever

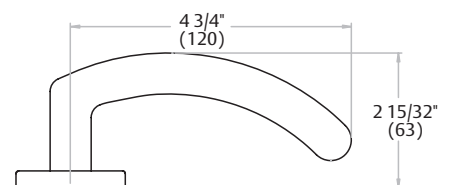

1. Complies with codes requiring lever to return to within 1/2" (13mm) of the door face

Muséo® Trim Designs

ML2000, ML20900 ECL and ML20600 NAC Series



Salvador

Dreamlike beauty manifested in solid, familiar forms.



110
Lever: Cast
Non-handed lever

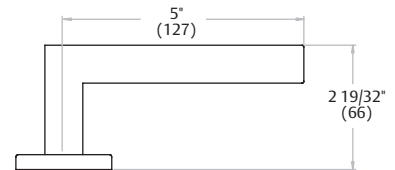

123¹
Lever: Cast
Non-handed lever

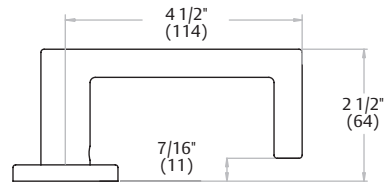

128¹
Lever: Cast
Non-handed lever

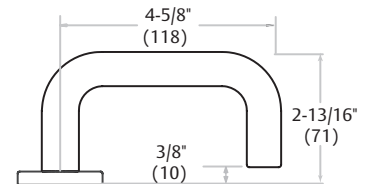

1. Complies with codes requiring lever to return to within 1/2" (13mm) of door face.

Muséo® Trim Designs

ML2000, ML20900 ECL and ML20600 NAC Series



Marc

Fluid lyricism expressed through whimsical lines and dynamic contours.



111^{1,2}

Lever: Cast
Handed - Specify hand
Non-Reversible

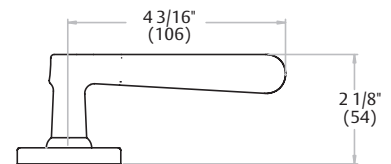

112²

Lever: Cast
Handed - Specify hand
Non-Reversible

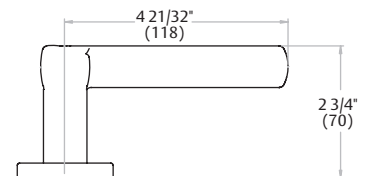

114²

Lever: Cast
Handed - Specify hand
Non-Reversible

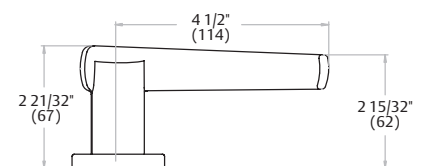

1. Not available with Inspire™ roseless trim.
2. Not available in 629 or 630 finish

Muséo® Trim Designs

ML2000, ML20900 ECL and ML20600 NAC Series



Marc

Fluid lyricism expressed through whimsical lines and dynamic contours.



115²

Lever: Cast
Handed - Specify hand
Non-Reversible

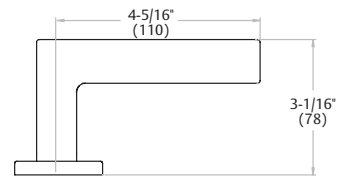

116²

Lever: Cast
Handed - Specify hand
Non-Reversible

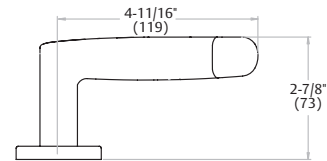

130^{1,2}

Lever: Cast
Handed - Specify hand
Non-Reversible

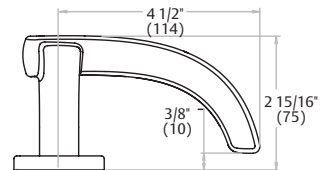

131^{1,2}

Lever: Cast
Handed - Specify hand
Non-Reversible

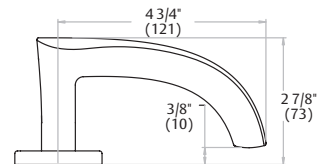

132^{1,2}

Lever: Cast
Handed - Specify hand
Non-Reversible

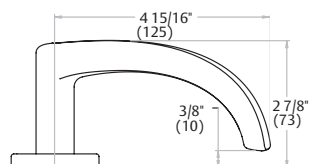

1. Complies with codes requiring lever to return to within 1/2" (13mm) of door face.
2. Not available in 629 or 630 finish

Muséo® Trim Designs

ML2000, ML20900 ECL and ML20600 NAC Series



Piet*

Striking levers with sleek, clean lines.

* Refer to page 78 for how to order the Muséo® Piet Lever Collection.
Not available with Inspire™ roseless trim.



21G
Grooved Insert
Lever: Cast
Non-Handed Lever

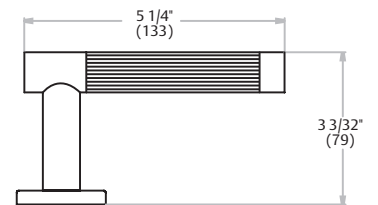

21L
Leather Insert
Lever: Cast
Non-Handed Lever

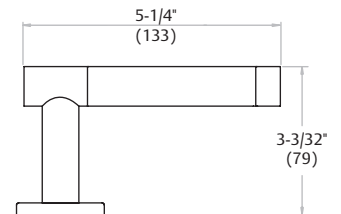

21M
Polished with Satin Insert
Lever: Cast
Non-Handed Lever

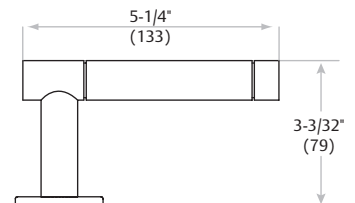

21S
Santoprene™ Insert
Lever: Cast
Non-Handed Lever

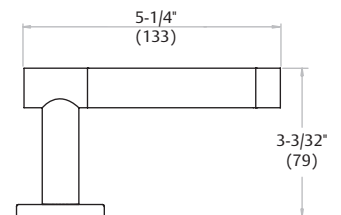

Muséo® Trim Designs

ML2000, ML20900 ECL and ML20600 NAC Series



Piet*

Striking levers with sleek, clean lines.

* Refer to page 78 for how to order the Muséo® Piet Lever Collection.
Not available with Inspire™ roseless trim.



23M
With Raised Band
Lever: Cast
Non-Handed Lever

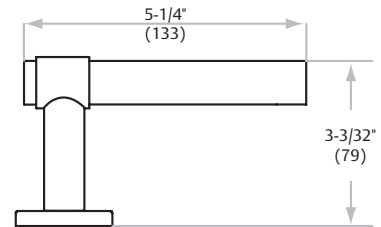

25M
Plain
Lever: Cast
Non-Handed Lever

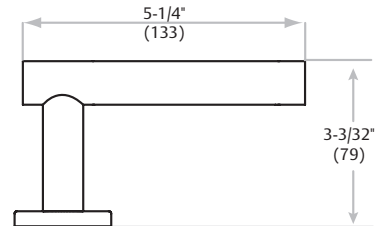

27M
Plain with Two Grooves
Lever: Cast
Non-Handed Lever

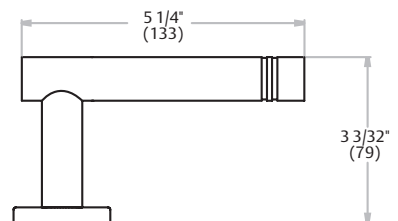

Muséo® Trim Designs

ML2000, ML20900 ECL and ML20600 NAC Series



Josef^{2/3}

Tribute to the square with beautifully simple, but dramatic forms.



133
Lever: Cast
Non-Handed lever

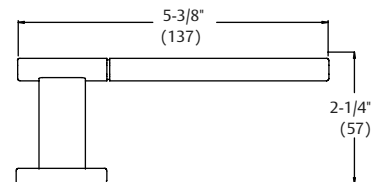

134¹
Lever: Cast
Non-Handed lever

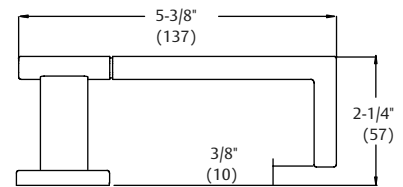

1. Complies with codes requiring lever to return to within 1/2" (13mm) of door face.
2. Not available with Inspire™ roseless trim.
3. 135-138 contain white or black polycarbonate insert

Muséo® Trim Designs

ML2000, ML20900 ECL and ML20600 NAC Series

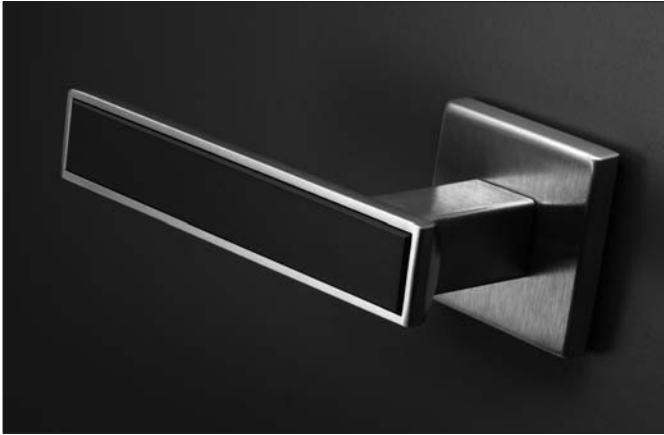

Josef^{2/3}

Tribute to the square with beautifully simple, but dramatic forms.



135
Lever: Cast
Non-Handed lever



136
Lever: Cast
Non-Handed lever

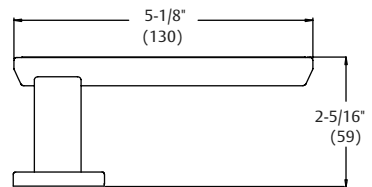

137¹
Lever: Cast
Non-Handed lever

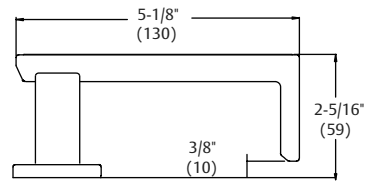

138¹
Lever: Cast
Non-Handed lever

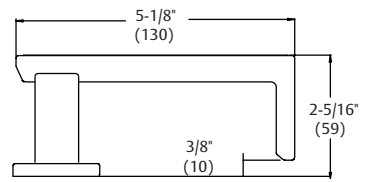

1. Complies with codes requiring lever to return to within 1/2" (13mm) of door face.
2. Not available with Inspire™ roseless trim.
3. 135-138 contain white or black polycarbonate insert

Muséo® Trim Designs

ML2000, ML20900 ECL and ML20600 NAC Series



Georges²

Structural pieces that evoke an emotional response with sophisticated design.



139

Lever: Cast
Non-Handed lever

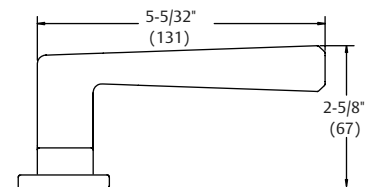

140

Lever: Cast
Handed lever

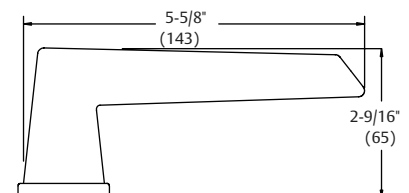

141

Lever: Cast
Non-Handed lever

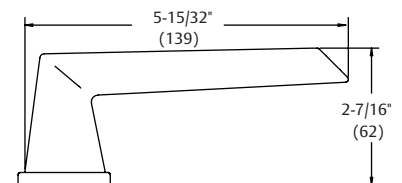

2. Not available with Inspire™ roseless trim.

Muséo® Trim Designs

ML2000, ML20900 ECL and ML20600 NAC Series



Georges²

Structural pieces that evoke an emotional response with sophisticated design.



142

Lever: Cast
Non-Handed lever



143

Lever: Cast
Non-Handed lever

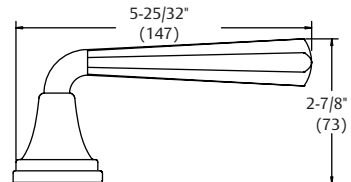

2. Not available with Inspire™ roseless trim.

Vineyard™ Collection Trim Designs

ML2000, ML20900 ECL and ML20600 NAC Series



Merlot

Like its namesake, the Merlot blends with — and enhances — any decor.



MSG

Lever: Cast
Rose: Cast

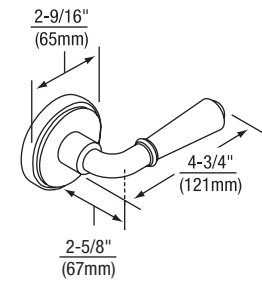

MSL

Lever: Cast
Escutcheon: Cast
Note: L escutcheon is not available for functions ML2087 or ML20987

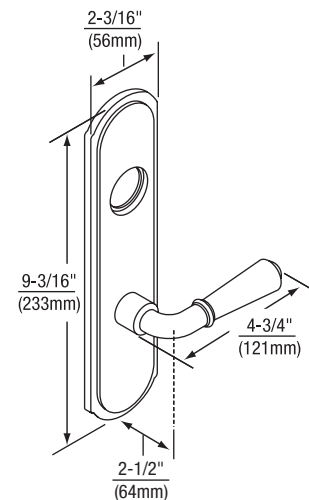

Vineyard™ Collection Trim Designs

ML2000, ML20900 ECL and ML20600 NAC Series



Zinfandel

Vigorous and complex in design, the Zinfandel adds finesse to any opening.

- Handed Levers



ZSG

Lever: Cast
Rose: Cast
Specify hand.

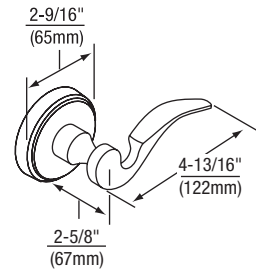

ZSL

Lever: Cast
Escutcheon: Cast
Specify hand.
Note: L escutcheon is not available for functions ML2087 or ML20987

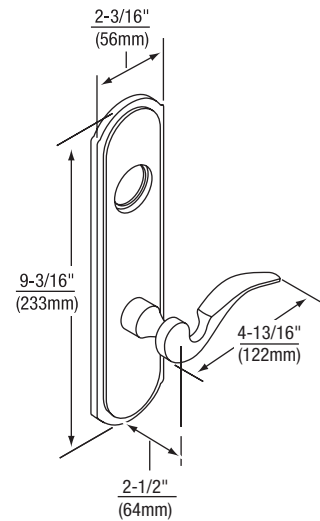

Vineyard™ Collection Trim Designs

ML2000, ML20900 ECL and ML20600 NAC Series



Frascati

Fresh yet classic, the Frascati exudes the casual, timeless elegance of the Roman hills.

- Non-Reversible
- Handed Levers



FSG

Lever: Cast
Rose: Cast

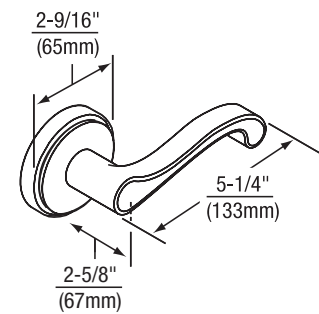

FSL

Lever: Cast
Escutcheon: Cast
Note: L escutcheon is not available for functions ML2087 or ML20987

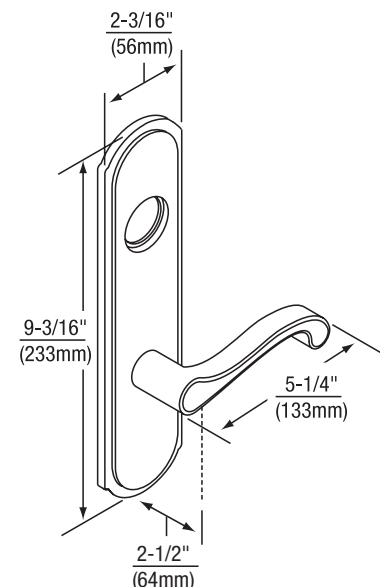

Muséo® Trim

ML2000, ML20900 ECL and ML20600 NAC Series

Muséo Collection Roses¹ and Escutcheons

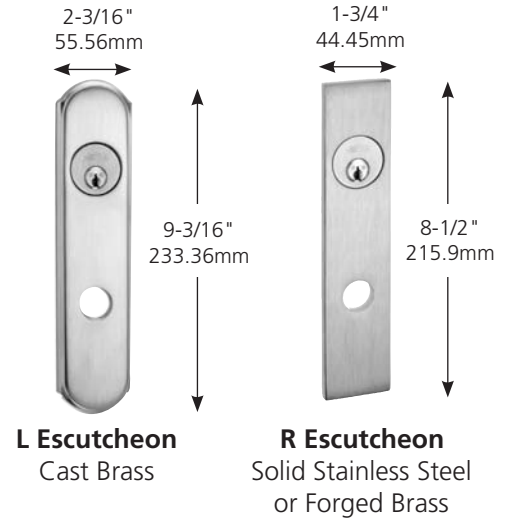
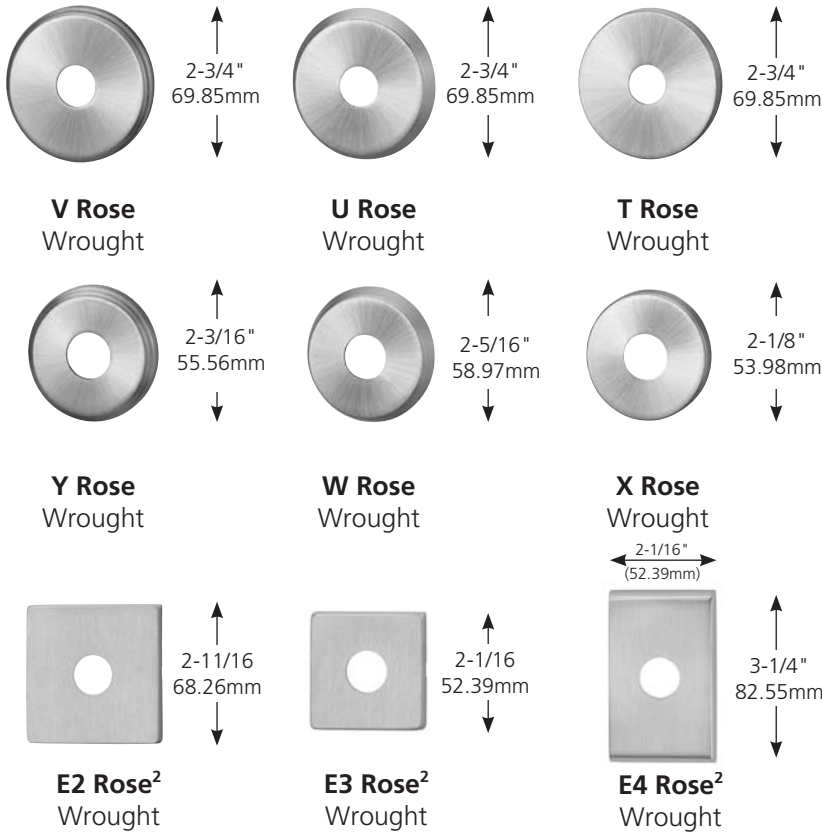

Thumbturns³

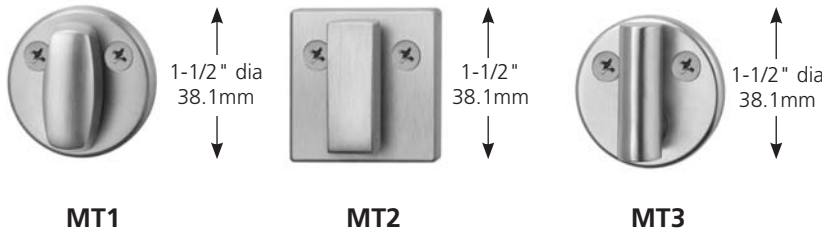

Inspire™ Roseless Trim

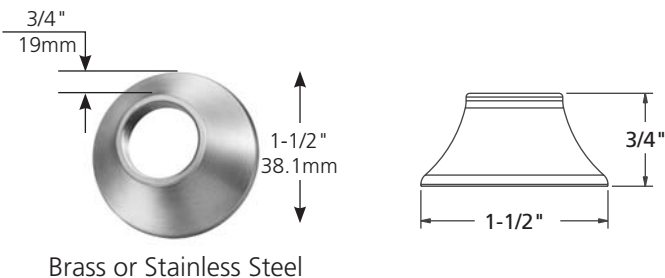

Notes:

1. Roses and Inspire trim are only available with *Muséo* levers.
2. Square cylinder collar and thumbturn backplate automatically supplied with E2, E3 and E4 roses.
3. Thumbturn back plate will match shape of rose chosen (i.e. round or square).
4. MT1, MT2 and MT3 are not available with M19VN indicator.
5. L & R escutcheons not available with functions ML2087 or ML20987

Inspire™ Roseless Trim

ML2000, ML20900 ECL and ML20600 NAC Series



Inspire™ Roseless Trim



Inspire roseless trim blends the lever and the door creating an artful approach to every opening. Offered with most Muséo® decorative levers, this exquisite trim will inspire the creation of beautiful openings.

Features:

- Certified to and exceeds ANSI/BHMA A156.13, Series 1000, Operational Grade 1 and Security Grade 1
- Attachment method similar to standard trim
- Available with all mortise lock functions
- Compatible with most Muséo Line levers (except 104, 111, 113, 121, Josef, Georges and Piet levers)
- Selected levers return within 1/2" of the door face
- All standard cylinder options are available
- Available for 1-3/4", 2" and 2-1/4" thick doors only (contact factory for other door thicknesses)

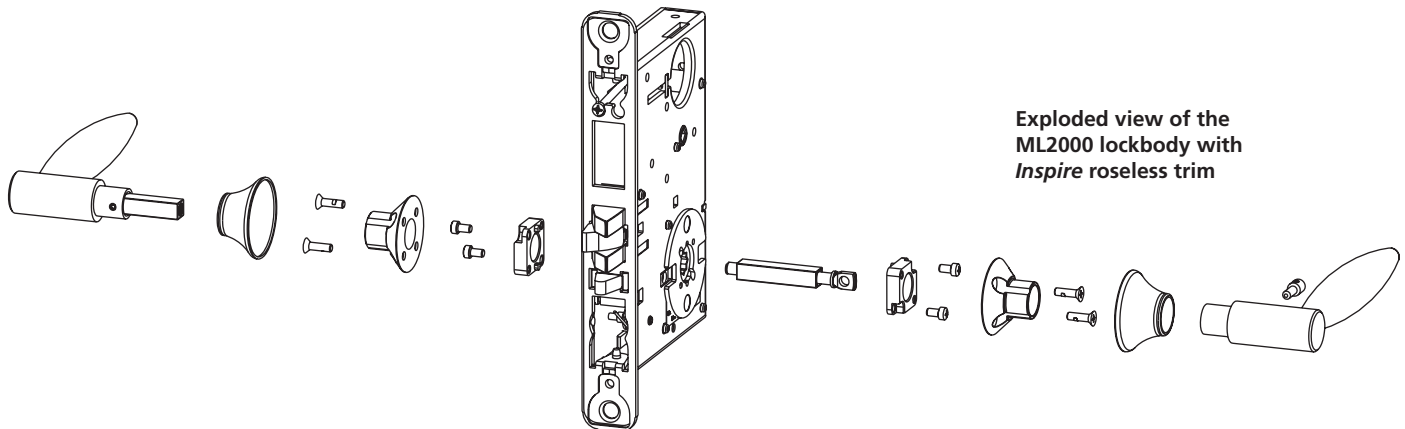

How to Order Inspire Roseless Trim

Quantity	Series/Function	Trim*	Finish	Hand
50	ML2055	102J	626	RHR

*Specify J for the rose when ordering Inspire roseless trim.

Behavioral Health Trim

ML2000, ML20900 ECL and ML20600 NAC Series



BHSS*

Part of the Behavioral Health Series® of products, the ML2000 Series mortise lock with BHSS trim provides an innovative solution for behavioral health environments. The unique integrated lever and escutcheon combines aesthetics with safety. Ease of operation, along with the strength and versatility of the ML2000 Series mortise lock allows its use in many applications.

Refer to the Healthcare Hardware Catalog (45205) for more information.



BHSS

Stainless Steel
Finishes: 630, 630C

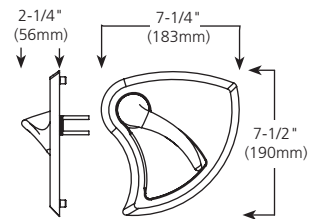

Thumbturn

Stainless Steel
Door thickness: 1-3/4" (44mm)
through 2-1/4" (57mm)

(Not available with Indicator)

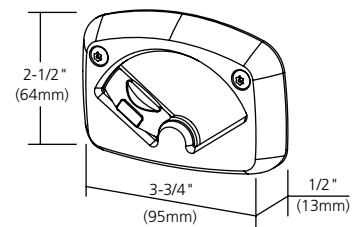

How to Order

BHSS

Quantity	Series/Function	Trim	Finish	Hand
100	ML2010	BHSS	630	RHR

**Although these products are better designed for behavioral health applications than traditional trim, they do not eliminate the risk that an object can be affixed to, or around them.*

Behavioral Health Lever Trim

ML2000, ML20900 ECL and ML20600 NAC Series



BLSS*

The BLSS trim is part of the Behavioral Health Series® of products. With an array of functions, this trim can be used on virtually any opening in healthcare applications. Sloping surfaces and overlapping rose and lever address safety concerns common in behavioral health. Optimal for tough environments, the ML2000 Series mortise lock provides impressive strength and reliability.

Refer to the Healthcare Hardware Catalog (45205) for more information.

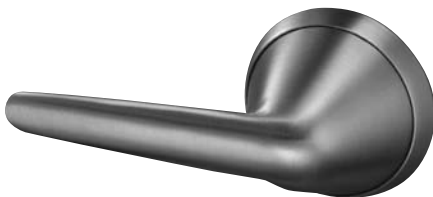

BLSS

Stainless Steel
Finishes: 630, 630C

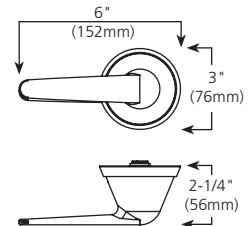

Thumbturn

Stainless Steel
Door thickness: 1-3/4" (44mm)
through 2-1/4" (57mm)

(Not available with Indicator)

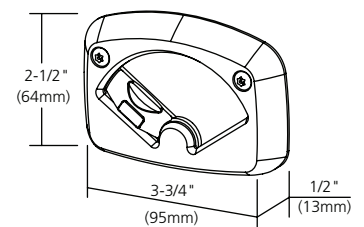

How to Order

BLSS

Quantity	Series/Function	Trim	Finish	Hand
100	ML2010	BLSS	630	RHR

**Although these products are a better design for behavioral health applications than traditional trim, they do not eliminate the risk that an object can be affixed to, or around them.*

Push/Pull Trim

ML2000, ML20900 ECL and ML20600 NAC Series



HPSK

The ML2000 Series mortise lock with push/pull paddle trim provides an aesthetically pleasing alternative to products with standard push/pull trim. Its heavy-duty design and ANSI/BHMA Grade1 strength help it to withstand abuse from rigorous environments. Multiple mounting orientations, hands free operation and a sleek, aesthetic form, make the ML2000 Series mortise lock ideal for use in healthcare facilities and educational facilities.

Refer to the Healthcare Catalog (45205) for more information.



HPSK

Covers: Cast stainless steel
Paddles: Cast stainless steel
Specify hand.
Finishes: 630, 630C
"PUSH & PULL" Identification available,
Quick Code M38.

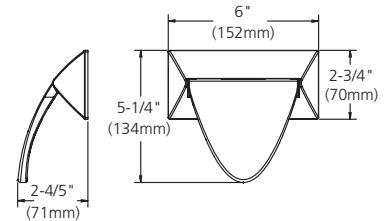

Thumbturn

Stainless steel
Door thickness: 1-3/4" (44mm)

(Not available with Indicator)

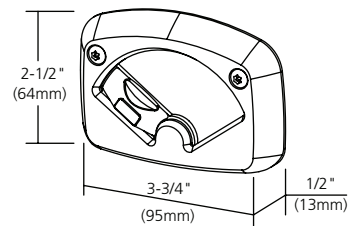

Laser Engraving

Stainless steel
Offered on all 3 paddle orientations
2-1/2" w x 2-1/2" h max laser engraving area
(See Custom Laser Engraving brochure for more details)

How to Order

HPSK Push/Pull*

Quantity	Series/Function	Trim	Finish	Hand
100	ML2010	HPSK	630	RHR

*Available on 1-3/4" door thickness only

Anti-Harm Trim

ML2000 Series



Anti-Harm Knob HSS*

The anti-harm knob is designed for safety and security by eliminating catch points with a tapered knob recessed into the rose, a tapered thumbturn (for mortise lock thumbturn functions) with Torx® pin security screws, tapered cylinder collars and concealed mounting screws. Available as sectional trim, the anti-harm knob features recessed finger holes for a better grip and the reliability of the ML2000 Series ANSI/BHMA grade 1 mortise lock. Ideal for psychiatric or detention facilities.

Refer to the Healthcare Hardware Catalog (45205) for more information.



Anti-Harm Knob HSS

Brass

Knob: Brass
Door thickness: 1-3/4" (44mm) through 4" (102mm) in 1/4" increments.
Finishes: 630, 630C

Notes: On lever trim x HSS Knob, the outside lever will be retained with a set screw.
HSS Knob is only available with the rose shown. No optional roses or escutcheons.
Knob and rose are nickel plated to match stainless steel.

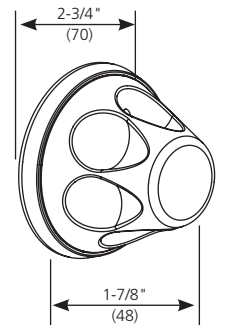

Thumbturn

Standard for all ML2000 x HSS thumbturn functions

(Not available with Indicator)

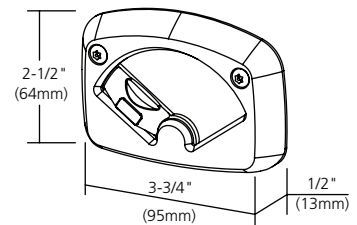

How to Order

Anti-Harm Knob (HSS) Trim – HSS Knob x HSS Knob

Quantity	Series/Function	Trim	Finish	Hand
6	ML2032	HSS	630^	RH

Anti-Harm Knob (HSS) Trim – Lever Trim x HSS Knob

Quantity	Series/Function	Trim		Finish	Hand
		Outside	Inside		
6	ML2055	NSA	HSS	630C^	RH

*Although these products are a better design for behavioral health applications than traditional trim, they do not eliminate the risk that an object can be affixed to, or around them.
^619 finish provided to match 630 finish

Vandal Resistant Trim

ML2000 Series

ML2000VR Series Vandal-Resistant Mortise Trim

Applications

Designed for high-traffic commercial, industrial, institutional and government buildings that require a greater degree of security and vandal resistance not found on other mortise trims. Applications may include:

- Schools and universities
- Computer rooms
- Hospital pharmacies
- Banks
- Storage facilities
- Government installations
- Prisons and detention facilities
- Evidence rooms
- Weapons storage
- Compatible with all ML2000, ML20900 and ML20600 x NAC functions except the following: ML2050, ML2070, ML2080, ML2087, ML20987

Advantages

- Flush-mounted conventional fixed core cylinder
- Cast escutcheons and levers; double through-bolted
- Torx® pin tamper resistant security screws
- Armored front to protect against tampering
- Free-floating spindle self-adjusts for door thicknesses from 1-3/4" to 2-1/4"
- Levers remain attached if spindle is broken



Newport

NSV

Lever: Cast stainless steel
Escutcheon: Cast stainless steel
Door thickness: 1-3/4" (44mm) standard, 2" (51mm) specify D200, 2-1/4" (57mm) specify D214

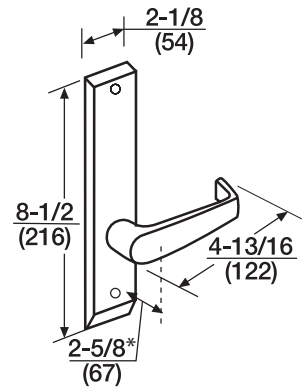

Citation

CSV

Lever: Cast stainless steel
Escutcheon: Cast stainless steel
Door thickness: 1-3/4" (44mm) standard, 2" (51mm) specify D200, 2-1/4" (57mm) specify D214

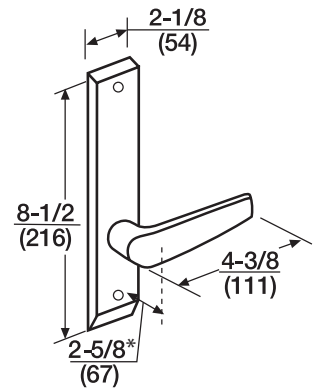

Note: only available in 630 (US32D) finish.

Indicators

ML2000 Series

ML2000 Series indicators can be used in a variety of applications and are most commonly used to identify occupancy or display the locked/unlocked status of a room.

- Restrooms
- Quiet rooms
- Nursing mother's rooms
- Classroom doors

Features

- Inside, outside or both sides of the door
- Sectional or escutcheon trim
- Available with 28 different functions – including thumbturn functions
- Viewing window 25% larger than competition
- Patented curved design for viewing at multiple angles
- Window located prominently above the cylinder
- Highly reflective viewing window for increased safety
- Optional directional engraving available – must specify handing
- Retrofittable for existing applications

Functions

Indicators are available with the following ML2000 and ML20600 Series functions.

ML2002, ML2003, ML2011, ML2012, ML2013, ML2017, ML2020, ML2022, ML2024, ML2029, ML2030, ML2040, ML2048, ML2049, ML2059, ML2060, ML2062, ML2065, ML2067, ML2068, ML2069, ML2072, ML2073, ML2075, ML2082, ML2092, ML20608 x NAC x SEC x PHR, ML20609 x NAC x SEC x PHR

See pages 4-9 & 19 for details.



Indicators

ML2000 Series

Sectional Trim

- Surface mounted
- Torx security screws provided
- Compatible with all sectional trim rose designs except E4
- Compatible with all thumbturn designs
- Available with optional directional arrow engraving
- Not compatible with master ring cylinders
- Not compatible with BHSS, BLSS, or HSS trims

Specify option code when ordered with lock. See page 66 for indicator option codes.

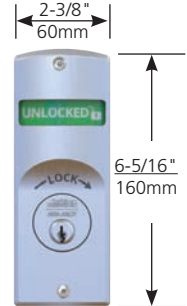

Retrofit/Upgrade Kits

Retrofit/upgrade kits are available for existing applications only. Each kit includes one indicator plate with mechanism, screw pack, plastic template and instructions.

To order retrofit/upgrade kits only, specify by model number below based upon function and mounting location. Door thickness and indicator option code must also be specified with kit.

Kits are handed and easily field reversible. All units are shipped from the factory with a default handing. Handing must be field verified and adjusted as needed per product installation instructions.

Retrofit/upgrade kits with directional engraving must include lock handing and lock function details.

See page 67 for how to order examples. Note: Indicators for both sides of door require two kits.

Illustration	Model #	Used with Functions	Available Option Codes	Indicator Location *
	ML190	ML2002, ML2003, ML2011, ML2012, ML2013, ML2017, ML2022, ML2024, ML2029, ML2048, ML2049, ML2059, ML2062, ML2065, ML2067, ML2068, ML2069, ML2072, ML2073, ML2075, ML2082, ML2092, ML20608 x NAC x PHR	Outside Trim: V10, V20, V30, V40, V50, V60 Inside Trim: V01, V03, V04, V06	Inside and/or Outside per Function
	ML193	ML2020, ML2030, ML2060	V10, V20, V30, V40, V50, V60	Outside
	ML194	ML2013, ML2017, ML2020, ML2024, ML2029, ML2030, ML2040, ML2048, ML2049, ML2060, ML2065, ML2067, ML2068, ML2069, ML2075, ML20608 x NAC x PHR, ML20609 x NAC x PHR	V01, V03, V04, V06	Inside
	ML197	ML2003, ML2011, ML2040, ML2059, ML2073, ML20609 x NAC x PHR	Outside Trim: V10, V20, V30, V40, V50, V60 Inside Trim: V01, V03, V04, V06	Inside or Outside per Function

*When indicators are required on both sides of the door, 2 upgrade kits must be ordered, one kit for each side.

Escutcheon Trim

- Unique escutcheon (VN) for both inside and outside of door for indicator functions
- Non-indicator functions provide with standard escutcheons as ordered, i.e. M, N, P, R, L
- Through-bolted
- Torx security screws optional
- Compatible with all thumbturn designs
- Available with optional directional arrow engraving
- Not compatible with select lever designs: 113, 121, 133, 134, 135, 136, 137, 138, 139, 140, 141, 142, 143
- Not compatible with master ring cylinders
- Not available with ML2011, ML2012 and ML2013

Specify option code when ordered with lock. See page 66 for indicator option codes.

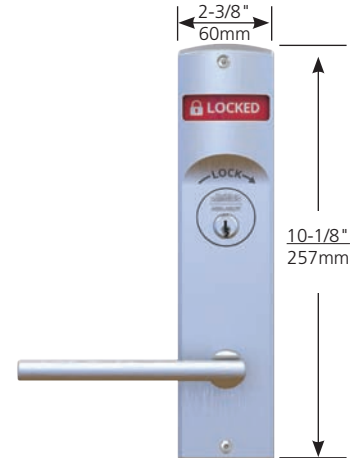

Trim Kits

Complete trim kits are available to retrofit/upgrade existing applications.

Trim kit includes levers and escutcheons with mechanism for both sides of door, screw pack, door marker and instructions.

To order trim kit only, specify by adding option code M31 and the indicator option code (see pg. 66 for codes) to the complete order string. See page 67 for how to order examples.

Option Code	Functions
M31	All functions*

*Escutcheon indicator trim kits available for all functions as listed on page 63 except ML2011, ML2012 and ML2013

Note: Escutcheon applications require both sides of the door to have the unique VN escutcheon. Kits will be provided as a set.

Indicators

ML2000 Series

Indicator Option Codes

ML2000 Series indicator option codes are designed to convey wording, color and side of door desired in one simple code. To order, specify option code for complete locksets and/or retrofit/upgrade trim kits.



Single Indicator			
Option Code	Outside Wording	Inside Wording	Color
V10	Unlocked/Locked	No Indicator	Green/Red
V10F	Ouvert/Fermé	No Indicator	Green/Red
V20	Vacant/Occupied	No Indicator	Green/Red
V20F	Libre/Occupée	No Indicator	Green/Red
V30	Icons Only	No Indicator	Green/Red
V40	Unlocked/Locked	No Indicator	White/Red
V50	Vacant/Occupied	No Indicator	White/Red
V60	Icons Only	No Indicator	White/Red
V01	No Indicator	Unlocked/Locked	Green/Red
V01F	No Indicator	Ouvert/Fermé	Green/Red
V03	No Indicator	Icons Only	Green/Red
V04	No Indicator	Unlocked/Locked	White/Red
V06	No Indicator	Icons Only	White/Red
Double Indicator			
Option Code	Outside Wording	Inside Wording	Color
V11	Unlocked/Locked	Unlocked/Locked	Green/Red
V11F	Ouvert/Fermé	Ouvert/Fermé	Green/Red
V21	Vacant/Occupied	Unlocked/Locked	Green/Red
V21F	Libre/Occupée	Ouvert/Fermé	Green/Red
V33	Icons Only	Icons Only	Green/Red
V44	Unlocked/Locked	Unlocked/Locked	White/Red
V54	Vacant/Occupied	Unlocked/Locked	White/Red
V66	Icons Only	Icons Only	White/Red
Engraving			
Option Code	Outside	Inside	Wording
EMA	Engraving	No Engraving	"Lock" with arrow
EMB	No Engraving	Engraving	"Lock" with arrow
EMC	Engraving	Engraving	"Lock" with arrow

Engraving Options

- Laser engraving with "LOCK" and directional arrow
- Only available in the following finishes: 605, 606, 618, 619, 625, 626, 626C
- Available with MicroShield®
- Door handing must be specified

Option Code	Description
EMA	Engraving located on outside of door
EMB	Engraving located on inside of door
EMC	Engraving located on inside and outside of door

Note: Engraving is available as an option for all functions when ordered with an indicator. Option codes must be specified with complete lock and/or retrofit (upgrade)/trim kits. EMC is not available with sectional trim upgrade kits.



How to Order Examples

Complete with Lock

Sectional Trim

Function	Lever	Rose	Hand	Finish	Options
ML2002	NS	A	RH	626	V01

Classroom Intruder function x sectional trim x single indicator inside – Unlocked/Locked – Green/Red

Escutcheon Trim

Function	Lever	Escutcheon	Hand	Finish	Options
ML2060	NS	VN	RH	626	V21 x EMB

Privacy function x escutcheon trim x double indicator - Vacant/Occupied - Green/Red (Outside)
Unlocked/Locked - Green/Red (Inside) x inside engraving with "Lock" and directional arrow

Retrofit (Upgrade)/Trim Kit Only

Sectional Trim*

Model #	Door Thickness	Finish	Options
ML190	1-3/4"	626	V01

Keyed function indicator for sectional trim x single indicator inside – Unlocked/Locked – Green/Red

* When indicators are required on both sides of the door, 2 upgrade kits must be ordered, one kit for each side.

All units are shipped from the factory with a default handing. Handing must be field verified and adjusted as needed per product installation instructions.

Escutcheon Trim

Function	Lever	Escutcheon	Hand	Finish	Options
ML2030**	NS	VN	RH	626	V21 x EMB x M31

Privacy function x escutcheon trim x double indicator - Vacant/Occupied - Green/Red (Outside)

Unlocked/Locked - Green/Red (Inside) x inside engraving with "Lock" and directional arrow x full working trim only

**The function of the existing lock is required so the proper escutcheons can be provided.

Indicators

ML2000 Series

Sectional Trim Only Indicators

The following indicators are available with sectional trim only and have different features and options than the indicators found on pages 63-67. To order the following sectional indicators with locksets, specify option codes M19S, M19V or M19N for single indicator and M19SN or M19VN for double indicators. See page 81 for option codes. Kits are available by specifying by part number as listed below. Sectional trim only indicators are available in functions as listed on pages 4-9 and 19.

Features:

- Design eliminates unauthorized entry via indicator tampering
- Non keyed indicators available with emergency slot turn override
- For use outside, inside or both sides of door
- Choose outside indicator text: Vacant/Occupied or Secure/Unsecure
- Torx pin security fasteners (standard with cylinder indicators)

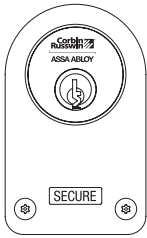

Keyed Functions

- Can be used on either side of door for double cylinder functions
- Compatible with select sectional trim rose designs: A, B, E3, H, J, W, X, Y
- Not available with Master Ring cylinders

Secure (M19S)	
Door	Packet
1-3/8" (35mm)	720F21 x Finish
1-3/4" (44mm) - 2" (51mm)	720F22 x Finish
2-1/4" (57mm)	720F24 x Finish
Over 2-1/4" (57mm)	720F25 x Finish

Vacant (M19V)	
Door	Packet
1-3/8" (35mm)	741F21 x Finish
1-3/4" (44mm) - 2" (51mm)	741F22 x Finish
2-1/4" (57mm)	741F23 x Finish
Over 2-1/4" (57mm)	741F24 x Finish

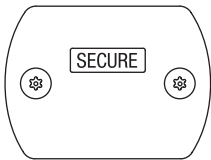

Inside Indicator

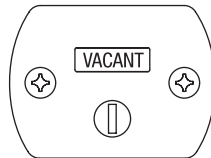

Outside Indicator

Non Keyed Functions

- Inside Indicator always reads Secure/Unsecure
- Outside Indicator features slot-turn emergency override
- Compatible with all sectional trim rose designs: A, B, E2, E3, E4, F, G, H, J, T, U, V, W, X, Y

Secure (M19S)	
Door	Packet
1-3/8" (35mm)	721F16 x Finish
1-3/4" (44mm) - 2" (51mm)	721F17 x Finish
2-1/4" (57mm)	721F18 x Finish
Over 2-1/4" (57mm)	721F19 x Finish

Vacant (M19V)	
Door	Packet
1-3/8" (35mm)	720F61 x Finish
1-3/4" (44mm) - 2" (51mm)	720F62 x Finish
2-1/4" (57mm)	720F64 x Finish
Over 2-1/4" (57mm)	720F65 x Finish

NOTE: M19S/M19SN not available with ML2020, ML2030, and ML2060

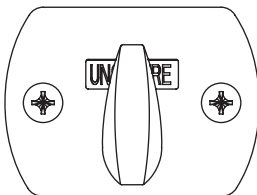

Thumbturn Functions

- Located on the inside of the door and reads Secure/Unsecure
- Compatible with all sectional trim rose designs: A, B, E2, E3, E4, F, G, H, J, T, U, V, W, X, Y

Secure (M19N)	
Door	Packet
1-3/8" (35mm)	723F69 x Finish
1-3/4" (44mm) - 2" (51mm)	723F26 x Finish
2-1/4" (57mm)	791F59 x Finish
Over 2-1/4" (57mm)	791F60 x Finish

Note: not available with BHSS or BLSS Trim

Experience a safer
and more open world

Copyright © 2001-2021, ASSA ABLOY Access and Egress Hardware Group, Inc. All rights reserved. Reproduction in whole or in part without the express written permission of ASSA ABLOY Access and Egress Hardware Group, Inc. is prohibited. Patent pending and/or patent www.assaabloydss.com/patents.

Thumbturns

ML2000 Series

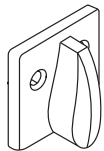
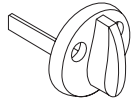

Standard Thumbturn

Cast brass or bronze. Standard on functions utilizing thumbturn. Sectional Trim.

Turn Size: 1-1/4" (32mm)

Spindle Size: 3/16" (5mm)

Plate Size: 1-3/8" (35mm)

Surface screw mounted To order separately, see table.

- Available with Standard, Muséo and Vineyard levers
- Rose design will designate shape of thumbturn backplate
 - E2, E3 and E4 roses - square backplate

Door	Packet	
	Round	Square
1-3/8" (35mm)	519F09 x FIN	814F10 x FIN
1-3/4" (44mm)	519F10 x FIN	814F11 x FIN
2-1/4" (57mm)	519F11 x FIN	814F12 x FIN
Up to 4" (102mm)	581F96 x FIN	814F13 x FIN

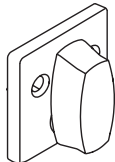

Decorative Thumbturn MT1*

Cast bronze or stainless steel. Used on functions utilizing a thumbturn. Sectional trim only. To order with lock and trim, specify Quick Code MT1. To order separately, see table.

Turn Size: 1-3/10" (33mm)

Plate Size: 1-1/2" (38.1mm)

- Available with Standard, Muséo and Vineyard levers
- Rose design will designate shape of thumbturn backplate
 - Round roses - round backplate
 - E2, E3 and E4 roses - square backplate

Door	Packet	
	Round	Square
1-3/8" (35mm)	723F70M x FIN	723F71M x FIN
1-3/4" (44mm)	723F76M x FIN	723F77M x FIN
2-1/4" (57mm)	723F88M x FIN	723F89M x FIN
Up to 4" (102mm)	723F82M x FIN	723F83M x FIN

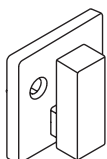
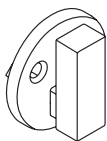

Decorative Square Thumbturn MT2*

Cast bronze or stainless steel. Used on functions utilizing a thumbturn. Sectional trim only. To order with lock and trim, specify Quick Code MT2. To order separately, see table.

Turn Size: 1-3/10" (33mm)

Plate Size: 1-1/2" (38.1mm)

- Available with Standard, Muséo and Vineyard levers
- Rose design will designate shape of thumbturn backplate
 - Round roses - round backplate
 - E2, E3 and E4 roses - square backplate

Door	Packet	
	Round	Square
1-3/8" (35mm)	723F72M x FIN	723F73M x FIN
1-3/4" (44mm)	723F78M x FIN	723F79M x FIN
2-1/4" (57mm)	723F90M x FIN	723F91M x FIN
Up to 4" (102mm)	723F84M x FIN	723F85M x FIN

*Not available with M19VN indicator.

Thumbturns

ML2000 Series

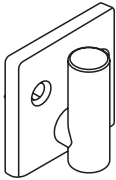

Decorative Cylinder Thumbturn MT3*

Cast bronze or stainless steel. Used on functions utilizing a thumbturn. Sectional trim only. To order with lock and trim, specify Quick Code MT3. To order separately, see table.

Turn Size: 1-3/10" (33mm)

Plate Size: 1-1/2" (38.1mm)

- Available with Standard, Muséo and Vineyard levers
- Rose design will designate shape of thumbturn backplate
 - Round roses - round backplate
 - E2, E3 and E4 roses - square backplate

Door	Packet	
	Round	Square
1-3/8" (35mm)	723F74M x FIN	723F75M x FIN
1-3/4" (44mm)	723F80M x FIN	723F81M x FIN
2-1/4" (57mm)	723F92M x FIN	723F93M x FIN
Up to 4" (102mm)	723F86M x FIN	723F87M x FIN

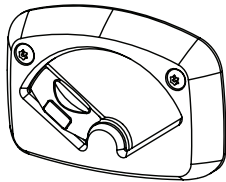

Thumbturn for BHSS, BLSS, HSS, HPSK

Stainless steel. Used on functions utilizing a thumbturn. Sectional trim only. To order, see table.

Plate Size: 3-3/4" (95mm) x 2-1/2" (64mm)

Door Thickness	Packet
1-3/4" (44mm)	851F627
2" (51mm)	851F637
2-1/4" (57mm)	851F647

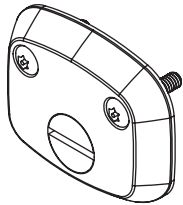

Emergency Turn for BHSS, BLSS, HSS, HPSK

Stainless steel. Used on functions utilizing a thumbturn. Sectional trim only. To order, see table.

Plate Size: 3-3/4" (95mm) x 2-1/2" (64mm)

Door Thickness	Packet
1-3/4" (44mm)	851F677
2" (51mm)	851F687
2-1/4" (57mm)	851F697

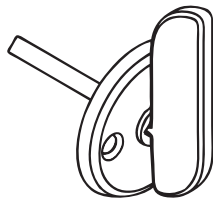

Ergonomic Thumbturn

Cast brass or bronze. Large profile and offset center makes it easier to grasp and rotate. Available on both sectional and escutcheon trim. To order with lock and trim, specify Quick Code M34. To order separately, see table.

Note: Not available with the M19N, M19SN, or M19VN indicators. Not available with HPSK trim.



Door	Packet
Escutcheon Trim up to 4" (102mm)	711F002
Sectional Trim	
1-3/8" (35mm) - 1-5/8" (41mm)	707F57 x FIN
1-3/4" (44mm) - 2" (51mm)	707F58 x FIN
2" (51mm) - 2-1/4" (57mm)	707F59 x FIN
2-3/8" (60mm) - 3" (76mm)	707F60 x FIN
3" (76mm) - 4" (102mm)	706F70 x FIN

*Not available with M19VN occupancy indicator.

Options and Accessories

ML2000 Series



Blank Plate

For use on doors where standard thumbturn is no longer used. To order, specify 696F39 x Finish.

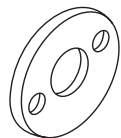

Key Plate

Cast brass or bronze. Standard for privacy function with emergency release only. Sectional Trim.

Plate Size: 1-3/8" (35mm) diameter. To order separately, specify Packet 438F90 x Finish.



Tapered Cylinder Collar

Furnished only for CSV or NSV trims with 1-1/4" cylinders, double cylinder functions or with 1-1/2" cylinders, single cylinder functions.*

*1-3/4" thick doors. Only used with VR trims.

Options and Accessories

ML2000, ML20900 ECL and ML20600 NAC Series

Cylinders

2 nickel silver keys
Finishes: See Key Systems catalog

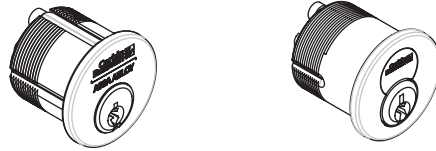

Mortise Cylinder Type	Quick Code	Hotel Function	42 (inside) 52, 53, 55, 56, 58, 69 Functions	All Other Keyed and 42 (outside) Functions
Access 3® Patented	AP	CR1501-114-A01	CR1500-114-A02	CR1500-114-A01
Access 3® Security	AS	CR1601-114-A01	CR1600-114-A02	CR1600-114-A01
Access 3® High Security	AHS	CR1701-114-A01	CR1700-114-A02	CR1700-114-A01
Access 3® Patented LFIC	ACP	N/A	CR1580-114-A02	CR1580-114-A01
Access 3® Security LFIC	ACS	N/A	CR1680-114-A02	CR1680-114-A01
Access 3® High Security LFIC	ACHS	N/A	CR1788-114-A02	CR1788-114-A01
Pyramid HS	PHS	N/A	CR1020-114-A02	CR1020-114-A01
Pyramid HS LFIC	PCHS	N/A	CR1030-114-A02	CR1030-114-A01
Pyramid Security	PS	N/A	CR1027-114-A02	CR1027-114-A01
Pyramid Security LFIC	PCS	N/A	CR1037-114-A02	CR1037-114-A01
Conventional 6-pin	N/A	CR1001-114-A01	CR1000-118-A02	CR1000-118-A01
Conventional 7-pin	7P	N/A	CR1000-114-A02-7	CR1000-114-A01-7
6-pin LFIC	C6	CR1081-138-A01	CR1080-114-A02	CR1080-114-A01
7-pin LFIC	C7	N/A	CR1080-112-A02-7	CR1080-112-A01-7
6-pin SFIC	C6S	N/A	CR1050-114-A02	CR1050-114-A01
7-pin SFIC	C7S	N/A	CR1050-114-A02-7	CR1050-114-A01-7
Security	HS	CR1011-114-A01	CR1010-118-A02	CR1010-118-A01
Security LFIC	CHS	CR1091-138-A01	CR1090-114-A02	CR1090-114-A01
Flex head 6-pin	FX6	CR1101-118-A01	CR1100-100-A02	CR1100-100-A01
Flex head 7-pin	FX7	N/A	CR1100-118-A02-7	CR1100-118-A01-7
Master ring**	MR	N/A	CR1060-118-A62	CR1060-118-A61
Master ring flex head**	FXM	N/A	CR1160-100-A62	CR1160-100-A61
Plug only to show-6-pin	P06	CR1201-114-A01	CR1200-118-A02	CR1200-118-A01
Plug only to show 7-pin	P07	N/A	CR1200-114-A02-7	CR1200-114-A01-7

To order cylinder separately, specify Part No. x Keyway x Finish (e.g., CR1000-118-A01 x L4 x 626). Refer to ML2000 Series parts manual for collar requirements.

**Not available for the following functions: ML2017, ML2029, ML2032, ML2068, ML20900, ML20600 x NAC. Available for "M" escutcheon and sectional trim only.

Note: Master ring cylinder meets ANSI/BHMA operational Grade 1.

Plug only to show (concealed shell)

Only the cylinder plug face is visible when lock trim is in place. Available with "M", "R", and "L" escutcheons. See individual trim designs for availability.

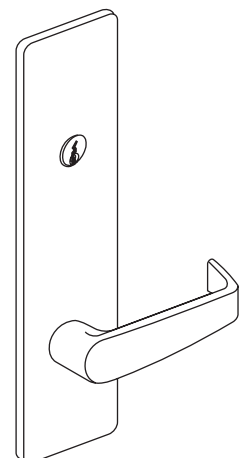

Options and Accessories

ML2000 Series, ML20900 ECL and ML20600 NAC

Strikes

ANSI Straight Lip (standard)

Brass or stainless steel

Non-handed

4-7/8" (124mm) x 1-1/4" (32mm) x 1-1/8" (29mm) lip to center (standard)

Optional lip lengths: 7/8" (22mm), 1"

(25mm), 1-1/8" (29mm), 1-1/4" (32mm),

1-3/8" (35mm), 1-1/2" (38mm), 1-3/4"

(44mm), 2" (51mm), 2-1/4" (57mm),

2-1/2" (64mm), 2-3/4" (70mm), 3" (76mm)

ANSI Curved Lip

Brass or stainless steel

Handed

4-7/8" (124mm) x 1-1/4" (32mm) x 1-1/4" (32mm) lip to center (standard)

Optional lip lengths: 1-1/8" (29mm), 1-3/8"

(35mm), 1-1/2" (38mm), 1-3/4" (44mm), 2"

(51mm), 2-1/4" (57mm), 2-1/2" (64mm),

2-3/4" (70mm), 3" (76mm)

ANSI Wrought Strike Box

To order with lockset, see

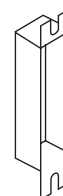

Quick Codes, page 80.

To order separately, specify 120F76.

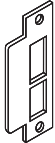

Open Back

Size: 5-1/4" (133mm) x 1/4" (32mm).

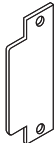
	Part No.	Description
Note: Only Available with ML2000	236L72	Straight Lip
  LH Shown	340L60	Curved Lip for RH/LHR
All Functions	340L61	Curved Lip for LH/RHR
 Blank Filler Plate	236L70	Straight Lip

To order strike with lockset, see How to Order, page 77.

To order strike separately, specify Part No. x Lip Length x Finish (e.g., 340L60 x 1-1/2" x 626).

Hand	Door Thickness	Part
RHR	1-3/4" (44mm)	411L62 016
	2" (51mm)	411L62 018
	2-1/4" (57mm)	411L62 020
LHR	1-3/4" (44mm)	411L63 016
	2" (51mm)	411L63 018
	2-1/4" (57mm)	411L63 020

To order with lockset, see Quick Codes, page 80. To order separately, specify Part No. x Door Thickness x Finish (e.g., 411L62 x 2" x 626).

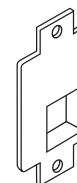

Rabbeted Front and Strike

Stainless Steel

For 1/2" (13mm) rabbet

No optional lip lengths

Non-handed

	Part No.
All Functions	318F66

To order with lockset, see Quick Codes, page 80. To order separately, specify Part No. x Finish (e.g., 318F66 x 626).

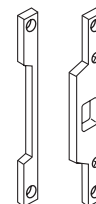

Options and Accessories

ML2000 Series, ML20900 ECL and ML20600 NAC

BPS Power Supply

Operation

Power supplies are designed to provide reliable filtered and regulated power for long life to a variety of electrified hardware components. All modular power supplies are designed to meet UL 1481 Standards. Recommended for the ML20900, delayed egress exit devices and electric trim.

Features

- Fire panel emergency release input
- PC Board mounted system LED indicator
- Regulated and filtered with input and output protection
- Battery charging is provided from a separate output terminal

Electrical Specifications

- Inputs: 115VAC @600mA
- Outputs: 12/24 VDC @ 1 Amp, 1.5 Amp or 4 Amp, Filtered and regulated output

Certifications

- cULus Listed Access Control System Accessories
- cULus Listed Special Locking Arrangements

Applications

- D – Delayed Egress
- M97 – Electric Dogging
- SAF – Fail Safe mortise device trim control
- SEC – Fail Secure mortise device trim control
- ML20900

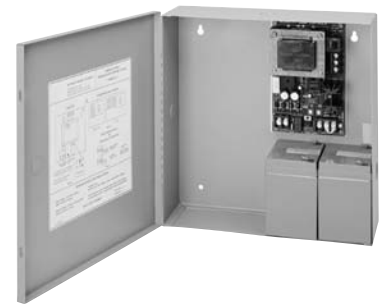

Note: Batteries are not included with the BPS power supply

Model	Enclosure	Input	Output
BPS-24-1	12" (304mm) x 9" (229mm) x 4" (102mm)	115VAC, 50/60 Hz.	1 Amp @ 24 VDC
BPS-24-2	14" (356mm) x 14" (356mm) x 4" (102mm)	115VAC, 50/60 Hz.	2 Amp @ 24 VDC
BPS-24-4	15" (381mm) x 18" (457mm) x 6" (152mm)	115VAC, 50/60 Hz.	4 Amp @ 24VDC
BPS-12-1	12" (304mm) x 9" (229mm) x 4" (102mm)	115VAC, 50/60 Hz.	1 Amp @ 12 VDC
BPS-12-3	14" (356mm) x 14" (356mm) x 4" (102mm)	115VAC, 50/60 Hz.	3 Amp @ 12 VDC

Requirements for Electrical and Data Transfer

To answer the demand for "smart" electronic access control and locking solutions that require fast, easy, and cost-effective installation, ASSA ABLOY Group brands use the ElectroLynx® standardized plug-in connectors and color-coded wiring system.

With *ElectroLynx*, doorway components come pre-wired for easy hookup to the power source. The key to the system is the transfer device hinge that carries power from the frame to the locking hardware.

Features of ElectroLynx:

- Makes it easy to bring power to the locking hardware
- Wires have connectors that snap together, like plugging a telephone into a jack

To connect a ML20900 electrified mortise lock to the electronic access control system, the following items are required:

- ML20900 electrified mortise lock
- ASSA ABLOY Door Group pre-wired door, or *ElectroLynx* retrofit cable (order from McKinney)

- Electronic transfer device (*ElectroLynx* electronic transfer hinge or Electrical Power Transfer with standard hinge, from McKinney)
- *ElectroLynx* cable from the hinge to above the ceiling (order from McKinney)

Information regarding cable selection, hinge requirements and order strings can be found in the McKinney Transfer Device Solutions catalog. Consult 800-810-WIRE (9473) with questions on application specifications and requirements.

The McKinney QC8 *ElectroLynx* Hinge is recommended for all ML20900 functions and electrified options.

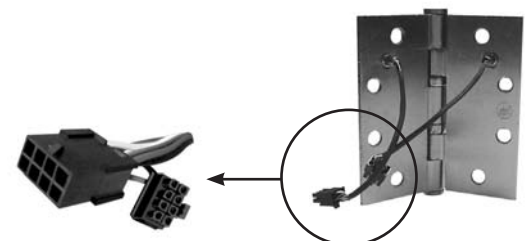

Electrified Options & Accessories

ML20900 ECL and ML20600 NAC

Exit Controls and Switches

Key Switches

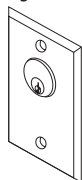

MKA

MKA - (1) SPDT Maintained
 MK - (1) SPDT Momentary
 MKN - (1) SPDT Momentary NS
 MK2 - (1) DPDT Momentary
 MKPZ x MKS - (1) SPDT Momentary with
 audio Double Gang x Additional Switch
 Note: All key switches come standard with
 12/24 VDC bi-color LED.

Specifications

- Keyswitch for operation using a standard 1-1/8" mortise cylinder (A02 cam) (cylinder not included).
- Contact Rating 5 Amps @ 12-24VDC
- SPDT 3-position.

Push Buttons

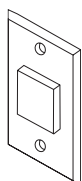

PB2

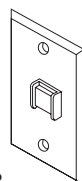

PB3

PB2 - (1) SPDT Momentary
 PB2 - (1) DPST Remote Momentary
 PB3 - (1) DPST Momentary
 PB3A - (1) DPST Maintained (Alt. Action)
 PB3EA - (1) DPST Alternate

Specifications

- 3 Amps @ 12-24 VDC

Indicator

ZLP - (1) Red and Green LED on narrow
 gang plate.

Audible/Visual Annunciators

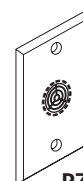

PZ1

PZ1 - Sonalert 90db @ 2ft. 12-24VDC.
 Mounted on one gang stainless steel plate.

Digital Entry

DK-11 - Digital Keypad - 4 User
 DK-26SS - Digital Keypad NS - 59 User -
 SS Finish
 DK-26BK - Digital Keypad NS - 59 User -
 Black Finish

Power Transfers

TSB B-C - Door Cord

How to Order

ML2000 Series

Ordering Examples - ML2000 Series

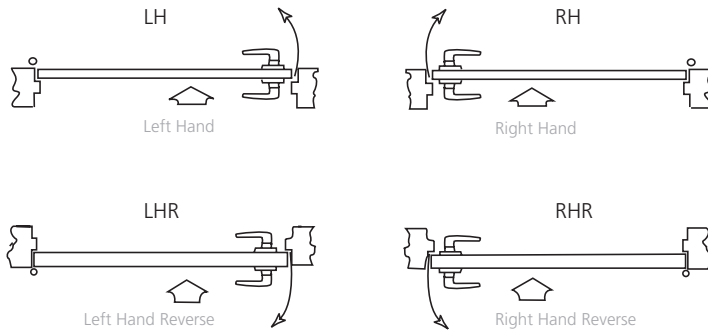

Note: Arrow indicates secure side of door.

Where to find ordering information and Quick Codes

ML2000 Series/Function	5-9
ML20900 ECL Series/Function	13
Trim Designs	14-54
Cylinder and Keying	69
Finish	69
Strikes	70
Miscellaneous Options	70
Door Thickness	70
Handing	71

Stock Order

Quantity	Series/Function	Trim	Finish	Hand
100	ML2055	LWA	626	RHR

Split Trim / Finish Order

Quantity	Series/Function	Trim		Finish		Hand
		Outside	Inside	Outside	Inside	
12	ML2055	LWA	GZH	626	625	RHR
12	ML2055	ZSL	—	626	625	RHR
24	ML2051	MSG	—	605	625	LH
12	ML2055	102U	—	626	606	RHR
24	ML2051	122R	110R	605	625	LH

Contract / Detailed Order

Quantity	Keyset	Series/Function	Trim	Finish	Hand	Door Thickness	Optional Strike	Misc. Options	Optional Cylinder	Keying
24	AA1	ML2055	LWA	626	RHR	D214	SA200	M17-M26	C7	VKC3
6	AA1	ML2055	NSV	630	RH	D214	SS114	M17	PCHS	VKC1

Working Trim Only

Quantity	Function Only	Trim	Finish	Hand	Door Thickness	Misc. Options
6	ML2055	LWA	626	RHR	D214	M31
1	ML2055	NSV	630	RH	D214	M31

(Includes grip and spindle, rose or escutcheon, thumbturn lever, emergency key plate, adapters and screws)

How To Order

ML2000 ECL, ML20900 ECL and ML20600 NAC Series

Lock Only (Includes lock case, armored front, strike and screw pack)

Quantity	Series/ Function	Trim*	Finish	Hand	Door Thickness	Optional Strike	Misc. Options
6	ML2055	LL	626	RHR	D138	SS078	M17

*TRIM KEY

KK	Knob x Knob
LL	Lever x Lever
LK	Lever x Knob
KL	Knob x Lever
HL	Lever Inside Only
HK	Knob Inside Only
LLBHSS	BHSS

Ordering Examples - ML20900 ECL Series

Lock Only (Includes lock case, armored front, strike and screw pack)

Quantity	Series/ Function	Trim*	Finish	Hand	Fail Safe/ Fail Secure	Misc. Options
6	ML20914	LL	626	RHR	SAF	M105

*TRIM KEY

KK	Knob x Knob
LL	Lever x Lever
LK	Lever x Knob
KL	Knob x Lever
HL	Lever Inside Only
HK	Knob Inside Only
LLBHSS	BHSS

Contract / Detailed Order

Quantity	Keyset	Series/ Function	Trim	Finish	Hand	Fail Safe/ Fail Secure	Misc.Options	Optional Cylinder	Keying
24	AA1	ML20914	LWA	626	RHR	SEC	M20	7P	VKC3

Ordering Examples - ML20600 NAC Series

Stock Order

Quantity	Series/Function	Technology Code	Trim	Finish	Hand	Fail-Safe/ Fail-Secure	High Security Monitoring Options
24	ML20608	NAC	111X	626	RHR	SEC	PHRR01

- ML2000 Mortise Lock x NAC x No Cylinder x Deadbolt x Fail-Secure
- Muséo® lever 111 with X rose
- Satin chrome finish
- Right hand reverse
- Deadbolt privacy function, Mercury and Lenel compatible 1KΩ/2KΩ resistance supervision

Stock Order

Quantity	Series/Function	Technology Code	Trim	Finish	Hand	Fail-Safe/ Fail-Secure	High Security Monitoring Options
24	ML20607	NAC	111X	626	RHR	SEC	R03

- ML2000 Mortise Lock x NAC x No Cylinder x No Deadbolt x Fail-Secure
- Muséo® lever 111 with X rose
- Satin chrome finish
- Right hand reverse
- Software House compatible 1KΩ/2KΩ resistance supervision

How to Order the Muséo® Piet Levers

ML2000 and ML20900 ECL Series



Grooved Insert
21G



Leather Insert
21L



Polished with
Satin Insert
21M



Santoprene™
Insert
21S



With Raised Band
23M



Plain
25M



Plain with Two
Grooves
27M

Piet Finish Codes

ANSI/BHMA & Corbin Russwin Finish Code	Piet Code*	Description
630	30	Satin Stainless Steel
629	29	Bright Stainless Steel
N/A	BK	Black (Santoprene™ or leather insert)
N/A	BN	Brown (leather insert)
N/A	00	No Insert
613E	E3	Dark Satin Bronze Equivalent
BSP	BS	Black Suede
WSP	WS	White Suede

*Code used to specify Piet Collection finishes only. Use available finishes list to specify desired finish when ordering.

Piet Lever Descriptions & Available Finishes

Lever Designation	Lever Description	Available Finishes (as ordered)
21G	Grooved Insert	303030, 292929, 293029, 302930, 3E003E, BP00BP, WS00WS
21L	Leather Insert	30BK30, 30BN30, 29BK29, 29BN29, 3EBK3E, BSBKBS, WSBKWS, 3EBN3E, BSNBNS, WSNBNS
21M	Metallic Insert	293029**
21S	Santoprene Insert	30BK30, 29BK29, 3E003E, BS00BS, WS00WS
23M	Raised Band	290030**, 290029, 300030, 300029***, 3E003E, BS00BS, WS00WS
25M	Plain	290029, 300030, 3E003E, BS00BS, WS00WS
27M	Two Grooves	290029, 300030, 3E003E, BS00BS, WS00WS

**Two-tone finish - grip of lever is 630, balance of lever is 629. Rose/escutcheon and lock finish will be 629.

***Two-tone finish - grip of lever is 629, balance of lever is 630. Rose/escutcheon and lock finish will be 630.

Ordering Examples

Rose Options: E2, E3, E4, T, U, V, W, X, Y

Escutcheon Options: L, R

Quantity	Series/Function	Trim	Lever Finish	Lock Finish	Hand	Thumbturn Options
2	ML2054	21LU	29BK29	629	RH	MT3
1	ML2054	23ML	290030	629	RH	MT3

Quick Codes

ML2000, ML20900 ECL and ML20600 NAC Series

Cylinder and Keying

Description	Specify
Conventional 6-pin	(standard)
Conventional 7-pin	7P
Less Cylinder(s)	LC
LFIC	
LFIC 6-pin	C6
LFIC 6-pin Less Core	CL6
LFIC 6-Pin Disposable Core	CT6D
LFIC 6-pin with Temporary Construction Core (Red)	CT6R
LFIC 6-pin with Temporary Construction Core (Blue)	CT6B
LFIC 6-pin with Temporary Construction Core (Green)	CT6G
LFIC 7-pin	C7
LFIC 7-pin Less Core	CL7
LFIC 7-Pin Disposable Core	CT7D
LFIC 7-pin with Temporary Construction Core (Red)	CT7R
LFIC 7-pin with Temporary Construction Core (Blue)	CT7B
LFIC 7-pin with Temporary Construction Core (Green)	CT7G
SFIC	
SFIC 6-pin	C6S
SFIC 6-pin Less Core ¹	CLS6
SFIC 6-Pin Disposable Core ¹	CT6SD
SFIC 6-pin with Temporary Construction Core (Blue)	CT6SB
SFIC 7-pin	C7S
SFIC 7-pin Less Core ¹	CLS7
SFIC 7-Pin Disposable Core ¹	CT7SD
SFIC 7-pin with Temporary Construction Core (Blue)	CT7SB
Security	
Security	HS
Security LFIC	CHS
Access 3[®]	
Access 3 [®] Patented Fixed Core	AP
Access 3 [®] Security Fixed Core	AS
Access 3 [®] High Security Fixed Core	AHS
Access 3 [®] Patented LFIC	ACP
Access 3 [®] Security LFIC	ACS
Access 3 [®] High Security LFIC	ACHS
Pyramid	
Pyramid Security Fixed Core	PS
Pyramid High Security Fixed Core	PHS
Pyramid Security LFIC	PCS
Pyramid High Security LFIC	PCHS
Pyramid LFIC Less Core	CLP
Pyramid with Temporary Construction Core	CTP
Pyramid Disposable Core	CTPD
UL Housing	
LFIC 6-pin Less Core ³	CL6AH
LFIC 6-Pin Disposable Core ³	CTAHD
LFIC 6-pin with Temporary Construction Core (Red/Blue/Green) ³	CT6AH (R/B/G)

Cylinder and Keying (cont.)

Description	Specify
Other	
Master Ring ^{2,4}	MR
Flex Head Cylinder, 6-pin (sectional trim) ³	FX6
Flex Head Cylinder, 7-pin (sectional trim) ³	FX7
Flex Head Cylinder, Master Ring (sectional trim) ^{2,3}	FXM
Plug Only to Show, Less Cylinder	PO-LC
Plug Only to Show, 6-pin (concealed shell; M and R escutcheons only, single cylinder only) ³	PO6
Plug Only to Show, 7-pin (concealed shell; M and R escutcheons only, single cylinder only) ³	PO7
Keying and Keys	
0-bitted with 2 blank keys	0Bit (standard)
Keyed Random	KR
Construction Master Keyed (not available for Pyramid)	CMK
Uncombined	UC
2 keys per lock	(standard)
More than 2 keys	KY# (e.g., KY6)
Visual key control (VKC)	
No biting or keyset stamping on keys or cylinder	VKC0
Keys only	VKC1
Cylinders and keys (not for AS, AHS, ACS, ACHS, HS, CHS, PHS or PCHS)	VKC2
Cylinders only (not for AS, AHS, HS, ACS, ACHS, CHS, PHS or PCHS)	VKC3
Concealed key control (CKC)	
CKC cylinders with VKC keys	CKC2
CKC cylinders only (not for AS, AHS, HS, ACS, ACHS, CHS, PHS or PCHS)	CKC3

1. Not available with ML2029.
2. Not available for ML2017, ML2029, ML2000VR, ML20600 or ML20900.
3. Not available with ML2000VR
4. Not available UC (uncombined)

Finishes

ANSI/BHMA 605 (US3)	Bright Brass
ANSI/BHMA 606 (US4)	Satin Brass
ANSI/BHMA 611 (US9)	Bright Bronze
ANSI/BHMA 612 (US10)	Satin Bronze
ANSI/BHMA 613 (US10B)	Oxidized Bronze, oil rubbed
613E (US10BE)	Dark Oxidized Satin Bronze - Equivalent
613L	Dark Oxidized Satin Bronze, Clear Coated
ANSI/BHMA 618 (US14)	Bright Nickel Plated
ANSI/BHMA 619 (US15)	Satin Nickel Plated
ANSI/BHMA 625 (US26)	Bright Chromium Plated
ANSI/BHMA 626 (US26D)	Satin Chromium Plated
626C	Satin Chromium Plated with MicroShield [®]
ANSI/BHMA 629 (US32)	Bright Stainless Steel
ANSI/BHMA 630 (US32D)	Satin Stainless Steel [®]
630C	Satin Stainless Steel with MicroShield [®]
722	Black Oxidized Bronze, oil rubbed
BSP	Black Suede Powder Coat
WSP	White Suede Powder Coat

Quick Codes

ML2000, ML20900 ECL and ML20600 NAC Series

Miscellaneous Options

Description	Specify
Spanner head screws	M02
Torx® head screws (not available for "N" escutcheon trims (Standard for ML2000VR. Optional for other trims)	M04
Blank Escutcheon Inside (only available for ML2000VR, not available for ML2000)	M07
ANSI wrought strike box	M17
*Knurling outside and inside	M20
*Knurling outside only	M21
*Knurling inside only	M22
*Abrasive coat outside and inside	M23
*Abrasive coat inside only	M24
*Abrasive coat outside only	M25
Non-ferrous lockcase (ML2000 only)	M26
Lead-wrapped case	M29
Half trim (for ML2010, ML2020, ML2022, ML2024, ML2029, ML2030, ML2032, ML2052, ML2053, ML2055, ML2056, ML2057, ML2058, ML2059, ML2062, ML2065) (Supplied with inside trim only. Includes cylinder) ^{1,2}	M30
Working trim only	M31
Latch hold back (for ML2042, ML2052, ML2053, ML2054, ML2055, ML2051, ML2057 only) ¹	LHB**
Tapered Cylinder Collar (HPSK only) ¹	M111
Laser Engraving	LASER

¹Not available with Vineyard™ or Muséo® levers

²Must use A02 cam when LHB is specified

1. Not available with R-Escutcheons or ML2000VR

2. Available for 1-3/8" (35mm), 1-3/4" (44mm), 2" (51mm) or 2-1/4" (57mm) thick doors.

Door Thickness⁺

Door Thickness	Sectional Trim - Specify	Escutcheon* Trim - Specify
1-3/8" (35mm)**	D138	D138
1-3/4" (44mm)	(standard)	(standard)
1-7/8" (48mm)	D178	D178
2" (51mm)	D200	D200
2-1/8" (54mm)	D218	D218
2-1/4" (57mm)	D214	D214
2-3/8" (60mm)	D238	D238
2-1/2" (64mm)	D212	D212
2-5/8" (67mm)	D258	D258
2-3/4" (70mm)	D234	D234
2-7/8" (73mm)	D278	D278
3" (76mm)	D300	D300
3-1/8" (79mm)	D318	D318
3-1/4" (83mm)	D314	D314
3-3/8" (86mm)	D338	D338
3-1/2" (89mm)	D312	D312
3-5/8" (92mm)	D358	D358
3-3/4" (95mm)	D334	D334
3-7/8" (98mm)	D378	D378
4" (102mm)	D400	D400

+ HPSK is only available for 1-3/4" door thickness

* For 2-3/8" (60mm) to 4" (102mm) door thickness: throughbolts and thumbturn lever spindle for 4" door will be provided; may be field cut. "R" & "L" escutcheons only available 1-3/8" (35mm), 1-3/4" (44mm), and 2-1/4" (57mm).

** 1-1/16" (27mm) front standard for 1-3/8" (35mm) door

Strikes

Available for ML2000VR

ANSI Lip to Center	ANSI Straight Lip Specify	Curved Lip Specify
7/8" (22mm)	SS078	N/A
1-1/8" (29mm)	(standard)	SA118
1-1/4" (32mm)	SS114	SA114
1-3/8" (35mm)	SS138	SA138
1-1/2" (38mm)	SS112	SA112
1-3/4" (44mm)	SS134	SA134
2" (51mm)	SS200	SA200
2-1/4" (57mm)	SS214	SA214
2-1/2" (64mm)	SS212	SA212
2-3/4" (70mm)	SS234	SA234
3" (76mm)	SS300	SA300
Open Back Strike	Door Thickness	Specify
	1-3/4" (44mm)	SB134
	2" (51mm)	SB200
	2-1/4" (57mm)	SB214
Rabbeted front and strike	–	Specify SR118

Indicator Options

Description	Specify
Single Indicator Outside - Unlocked/Locked - Green/Red	V10
Single Indicator Outside - Vacant/Occupied - Green/Red	V20
Single Indicator Outside - Icons Only - Green/Red	V30
Single Indicator Outside - Unlocked/Locked - White/Red	V40
Single Indicator Outside - Vacant/Occupied - White/Red	V50
Single Indicator Outside - Icons Only - White/Red	V60
Single Indicator Inside - Unlocked/Locked - Green/Red	V01
Single Indicator Inside - Icons Only - Green/Red	V03
Single Indicator Inside - Unlocked/Locked - White/Red	V04
Single Indicator Inside - Icons Only - White/Red	V06
Double Indicator - Unlocked/Locked - Green/Red (Outside) Unlocked/Locked - Green/Red (Inside)	V11
Double Indicator - Vacant/Occupied - Green/Red (Outside) Unlocked/Locked - Green/Red (Inside)	V21
Double Indicator - Icons Only - Green/Red (Outside) Icons Only - Green/Red (Inside)	V33
Double Indicator - Unlocked/Locked - White/Red (Outside) Unlocked/Locked - White/Red (Inside)	V44
Double Indicator - Vacant/Occupied - White/Red (Outside) Unlocked/Locked - White/Red (Inside)	V54
Double Indicator - Icons Only - White/Red (Outside) Icons Only - White/Red (Inside)	V66
Single Indicator Outside - Secure/Unsecure - Green/Red (Sectional trim only)	M19S
Single Indicator Outside - Vacant/Occupied - Green/Red (Sectional trim only)	M19V
Single Indicator Inside - Secure/Unsecure - Green/Red (Sectional trim only)	M19N
"Double Indicator - Secure/Unsecure - Green/Red (Outside) Secure/Unsecure - Green/Red (Inside) (Sectional trim only)"	M19SN
"Double Indicator - Vacant/Occupied - Green/Red (Outside) Secure/Unsecure - Green/Red (Inside) (Sectional trim only)"	M19VN
Outside Engraving with "Lock" and Directional Arrow	EMA
Inside Engraving with "Lock" and Directional Arrow	EMB
Engraving Both Sides with "Lock" and Directional Arrow	EMC

Note: Contact Customer Service for other available or custom configurations

Indicator Options - French

Description	Specify
Single Indicator Outside - Ouvert/Fermé - Green/Red	V10F
Single Indicator Outside - Libre/Occupée - Green/Red	V20F
Single Indicator Inside - Ouvert/Fermé - Green/Red	V01F
Double Indicator - Ouvert/Fermé - Green/Red (outside) Ouvert/Fermé - Green/Red (inside)	V11F
Double Indicator - Ouvert/Fermé - Green/Red (outside) Libre/Occupée - Green/Red (inside)	V21F

For V Series indicators only.

Handing

Hand	Specify
Right Hand	RH
Left Hand	LH
Right Hand Reverse	RHR
Left Hand Reverse	LHR

Electric Monitor Options (ML2000/ML20900 Series Only)

Description	Specify
Latchbolt Monitor	M91
Request to Exit	M92
Security Monitor	M105

These options may be ordered together only as follows:
M91xM92, M92xM105.

Panel Applications (Material added to the door face, increasing the overall door thickness)

Description	Specify
Centerline of lockcase to edge of panel not to exceed 2"	PNL

- Panel Application option code can only be used with 1 3/4" thick door with lock centered in door.
- You must specify the thickness of the panel and which side of the door the panel will be applied.
- All other applications require Special Product Application request.

Quick Codes

ML2000, ML20900 ECL and ML20600 NAC Series

Functions Available with Monitor Options

Function	M91	M92	M105	M91 + M92	M92 + M105
ML2010, ML2080, ML2090		X			
ML2020, ML2022, ML2024, ML2030, ML2062, ML2065	X	X		X	
ML2029*, ML2032*, ML2049*, ML2057*, ML2059*, ML2092*	X	X	X	X	X
ML2002, ML2003, ML2042, ML2052, ML2053, ML2054, ML2055, ML2056, ML2058, ML2087		X	X		X
ML2048, ML2051, ML2067, ML2082	X				
ML20906, ML20907, ML20914, ML20915, ML20932, ML20987	X	X	X	X	X

*M105 becomes DPS

Notes:

- ML2051 & ML2057 with LHB is not available with monitor options.
- Functions with monitor options are not available with M30 option (half trim).

Fail Safe/Fail Secure

Description	Specify
Fail safe	SAF
Fail secure	SEC

Thumbturns

Description	Specify
Ergonomic	M34
Decorative	MT1
Decorative Square	MT2
Decorative Cylinder	MT2

See page 69-70 for images of decorative thumbturns

ML20600NAC - End-of-Line Resistors and Deadbolt Privacy Quick Code

Description	Specify
No End-of-Line Resistors	Blank
Mercury / Lenel 1K Ω /2K Ω	R01
Software House 1K Ω /2K Ω	R03
AMAG 4-State Supervision	R04
Deadbolt Privacy	PHR
Deadbolt Privacy and Mercury / Lenel 1K Ω /2K Ω	PHRR01
Deadbolt Privacy and Software House 1K Ω /2K Ω	PHRR03
Deadbolt Privacy and AMAG 4-State	PHRR04

Electric Accessories

Description	Specify
Power supply 1.0 Amp @ 12 VDC output	BPS-12-1
Power supply 3.0 Amp @ 12 VDC output	BPS-12-3
Power supply 1.0 Amp @ 24 VDC output	BPS-24-1
Power supply 2.0 Amp @ 24 VDC output	BPS-24-2
Power supply 4.0 Amp @ 24 VDC output	BPS-24-4

ML2000 Series Suggested Specification

All locksets shall be ML2000 Series Mortise Locksets as manufactured by Corbin Russwin Architectural Hardware.

Locks shall have all functions available in one size case, manufactured from heavy gauge steel, minimum thickness 3/32" (2mm). The handing of all locks shall be reversible without the disassembly of the lockcase. Cases are to be closed on all sides to protect internal parts. Locks are to have adjustable, beveled and armored fronts, standard 2-3/4" (70mm) backset, a full 3/4" (19mm) throw two-piece mechanical anti-friction latchbolt, and a one-piece stainless steel 1" (25mm) throw deadbolt, and shall be available for a minimum door thickness of 1-3/8" (35mm). Internal parts shall be heavy gauge steel, zinc dichromate plated for corrosion resistance.

All locksets with latchbolts, regardless of trim, shall be listed by Underwriters

Laboratories for A label and lesser class doors, 4' x 10' single or 8' x 10' pair.

Locksets to be used on specified exterior doors or doors subject to special atmospheric conditions (roofs, pool areas, chemical laboratories, sewage disposal plants, etc.) shall have non-ferrous lock cases and critical internal components.

Cylinder options shall include master ring, flexible head, concealed shell, interchangeable core, security, Pyramid and Access 3 types.

Lock trim (knob, lever, sectional or escutcheon) shall be throughbolted through the lockcase to ensure correct alignment and proper operation.

Provide status indicators with highly reflective color and wording for "locked/unlocked" or "vacant/occupied" with customer wording options if required.

Indicator to be located above the cylinder with the inside thumbturn not blocking the visibility of the indicator status. Indicator window size to be a minimum of 2.1" x 0.6" with a curved design allowing a 180 degree viewing angle with protective covering to prevent tampering.

Certification:
 UBC - 7 - 2 and UL10C - Positive Pressure
 ANSI/BHMA A156.13 Series 1000, Grade 1
 ANSI/BHMA A117.1, Accessibility Code (formerly Title 19, California State Fire Marshal Standard) (lever handle trim).

All locks, trim, and cylinders shall be from one manufacturer.

All locksets shall carry a ten-year limited warranty.

ML2000 Series Mortise Locks with BHSS and BLSS Trim

- A. Ligature Resistant, Mortise: ANSI/BHMA A156.13, Series 1000, Operational and Security Grade 1 mortise type manufactured to accepted OMH requirements with ligature-resistant lever and escutcheon trim. Locksets to be manufactured with a corrosion resistant, formed steel case. Levers and escutcheons are manufactured from stainless steel material. Provide optional lead-lining (lock body), Torx® fasteners, and Antimicrobial coating as specified in Hardware Sets.
- B. Ligature Resistant, Mortise: ANSI/BHMA A156.13, Series 1000, Operational and Security Grade 1 mortise type manufactured to [accepted] [Use with caution] OMH requirements with ligature-resistant lever and rose trim. Locksets to be manufactured with a corrosion resistant, formed steel case. Levers and roses are manufactured from stainless steel material. Provide optional lead-lining (lock body), Torx® fasteners, and Antimicrobial coating as specified in Hardware Sets.

How To Specify

ML2000 Series

ML2000 Series Mortise Locksets with Vandal Resistant Trim Suggested Specification

All locksets shall be ML2000VR Series Mortise Locksets with Vandal Resistant Trim as manufactured by Corbin Russwin Architectural Hardware.

Locks shall have all functions available in one size case, manufactured from heavy gauge steel, minimum thickness 3/32" (2mm). The handing of all locks shall be reversible without the disassembly of the lockcase. Cases are to be closed on all sides to protect internal parts. Locks are to have adjustable, beveled and armored fronts, standard 2-3/4" (70mm) backset, a full 3/4" (19mm) throw two-piece mechanical anti-friction latchbolt, and a one-piece stainless steel 1" (25mm) throw deadbolt, and shall be available for a minimum door thickness of 1-3/4" (44mm). Internal parts shall be heavy gauge steel, zinc dichromate plated for corrosion resistance.

High security escutcheon trim shall be cast (stainless) steel with tapered design top and bottom to resist forced entry, excessive abuse and vandalism. Size to be

8-1/2" (216mm) high x 2-1/8" (54mm) wide x 5/16" (8mm) thick with double throughbolts and 2 post lugs to receive torx® pin tamper-resistant security screws through both escutcheons. Alignment posts shall be located over and under the spindle for rigidity and security and shall project through the lock case to ensure proper alignment. Escutcheons to accept cast levers (Newport or Citation) which accept free-floating spindles with a torque resistance of 700 inch lbs. Size of spindle to be 5/16" (8mm) and extend from both sides of the escutcheon. Levers will remain attached if spindle is broken. Lobular torx® pin drive self-tapping screws and lobular throughbolts furnished standard for vandal resistance.

Locksets that are to be used on specified exterior doors or doors subject to special atmospheric conditions (roofs, pool areas, chemical laboratories, sewage disposal plants, etc.) shall have non-ferrous lock cases and critical internal components.

Locksets to be furnished standard with conventional 6-pin fixed core cylinders. Optional cylinders shall include IC, Access 3, security and Pyramid. Furnish a tapered vandal-resistant cylinder collar where necessary.

Certification:
UBC - 7 - 2 and UL10C - Positive Pressure
ANSI/BHMA A156.13 Series 1000, Grade 1
ANSI/BHMA A117.1, Accessibility Code (formerly Title 19, California State Fire Marshal Standard) (lever handle trim).

All locks, trim, and cylinders shall be from one manufacturer.

All locksets shall carry a ten-year limited warranty.

ML20900 ECL Series Suggested Specification

ECOFLEX® ELECTRIFIED MORTISE LOCKS

A. CORBIN RUSSWIN ML20900

Electrified Mortise Locks

1. General: ANSI/BHMA certified extra heavy duty, lever type mortise lock conforming to ANSI/BHMA A156.13 Series 1000, Grade 1 requirements and ANSI A117.1 accessibility guidelines. All functions manufactured in a single sized case formed from a minimum 12 gauge steel. Lockset is field-adjustable for handing without opening the lock body with a beveled armored front that is 0.125" minimum thickness and utilizes a one piece 3/4" anti-friction stainless steel latchbolt. To insure proper alignment, all trim, shall be thru-bolted and fully interchangeable between rose and escutcheon designs. Lock is UL/cUL listed and labeled for use on up to 3 hour fire rated openings.
 - a. Backsets: 2-3/4".
 - b. Deadbolt: Optional 1" throw made of stainless steel and 2 hardened steel roller inserts.
 - c. Strikes: Provide wrought boxes and strikes with proper lip length to protect trim but not to project more than 1/8" beyond trim, frame or inactive leaf. Where required, provide open back strike and protected to allow practical and secure operation.
2. Provide access control mortise lock series, type and functions where specified in hardware groups, with provisions below:
 - a. Emergency override access capability with key cylinder retraction of lock latch bolt without necessary electronic activation.
 - b. Inside lever retracts latch and deadbolt simultaneously for free egress.
 - c. Refer to "KEYING" specification section for keying system requirements.
 - d. Lever and finish to match corresponding mechanical locking hardware.
3. Locking and unlocking of the lever handle by electronic operation contained completely within the body of the mortise lock.
 - a. Field configurable Fail Safe /Fail Secure by means of an external DIP switch setting.
 - b. Operationally voltage-insensitive 12 to 24 VDC.
 - c. Energy Performance: Maximum standby current required for functional operation not to exceed 50 mA at 24 VDC limiting potential inductive kickback or the need for external diodes.
 - d. Functional locking operation not affected by cable runs greater than 500 feet using a minimum 22 AWG wire.
4. Monitoring: Optional real time monitoring of latchbolt, deadbolt, door open/closed status and valid egress where specified. Valid egress signaled by activation of the Request-to-Exit (RX) micro switch integral to the inside lever of the lockset on the unsecure side of the door capable of shunting external alarms. Door open/closed status provided by monitoring the deadlatch and latchbolt in series with optional integrated magnetic door position switch. In fail safe operation both levers activate Request-to-Exit (RX) micro switch when the lock loses power.
5. Perform centralized control of the integrated locking functions by means of a single cable run to the access control panel independent of any proprietary power supplies, interface boards or controllers.
 - a. End of line termination points by means of factory pre-wired Molex® connectors and harnesses.
 - b. Source power electrical hard wiring and connections by others.

Reversing Handing

ML2000 Series

Instructions for reversing the hand of the ML2000 Series.

Step 1) Move the Red locking screw to side of lock-body being locked (Fig. 1)

Step 2) Push in latch then depress catch plate with screw driver (Fig. 1)

Step 3) Pull latch out of lock-body and turn latch over (Fig. 2)

Step 4) Push in latch while holding screw driver behind latch tail (Fig. 3)

Note: Push in latch until catch plate is no longer depressed (Fig. 4)

Step 5) Rotate lock front to match bevel of door as shown (Fig. 5)

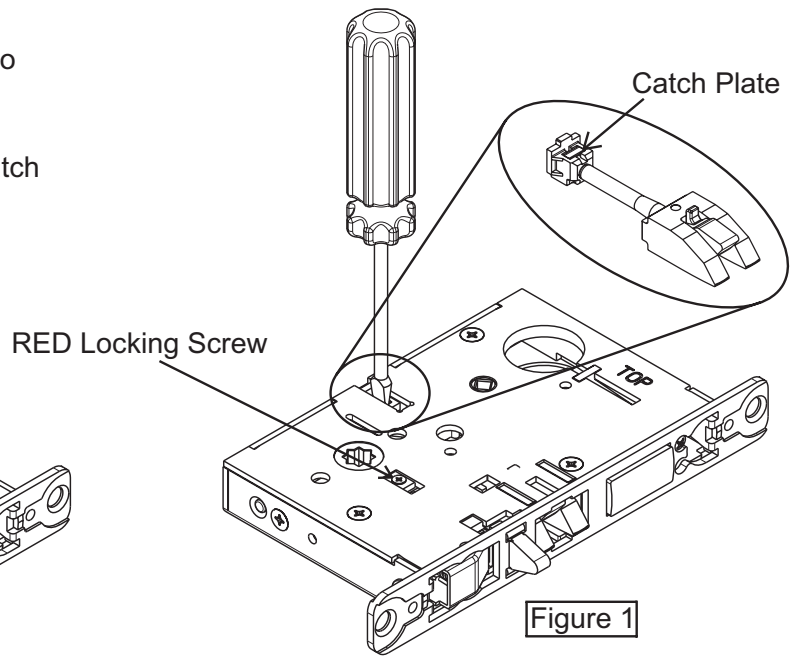

Figure 1

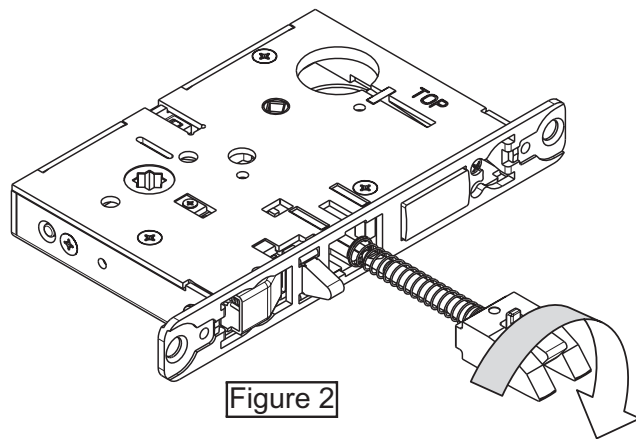

Figure 2

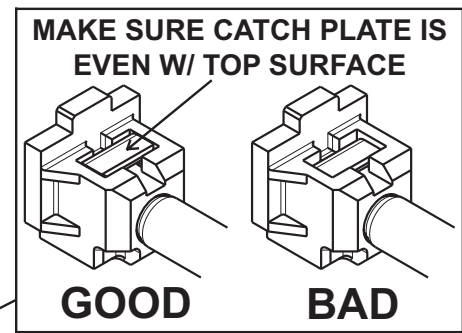

Figure 4

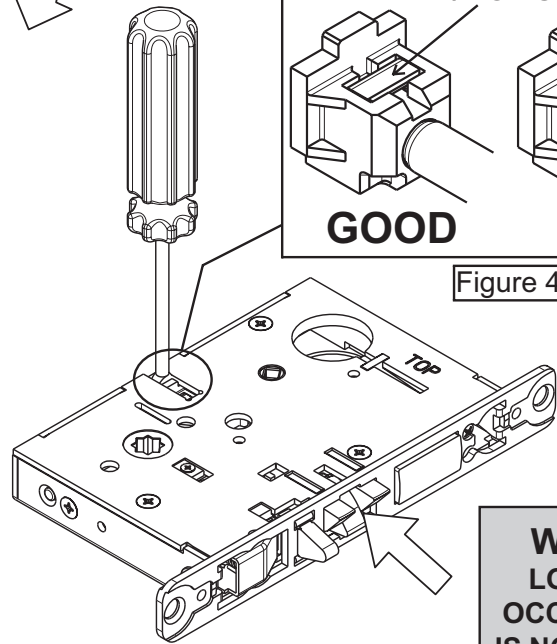

Figure 3

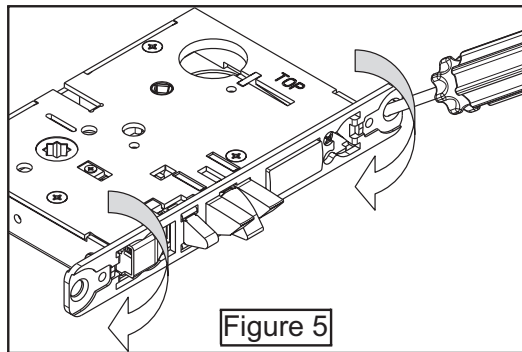

Figure 5

WARNING:
LOCK-IN CAN
OCCUR IF LATCH
IS NOT PROPERLY
INSTALLED

Notes

ML2000 Series

The ASSA ABLOY Group is the global leader in access solutions. Every day, we help billions of people experience a more open world.

ASSA ABLOY Opening Solutions leads the development within door openings and products for access solutions in homes, businesses and institutions. Our offering includes doors, door and window hardware, locks, access control and service.



For additional information, contact your
ASSA ABLOY Door Security Solutions
sales consultant or visit www.corbinruswin.com.

In U.S.

Corbin Russwin
225 Episcopal Road
Berlin, CT 06037
Phone: 800-543-3658
Fax: 800-447-6714
www.corbinruswin.com

In Canada

ASSA ABLOY Door
Security Solutions Canada
160 Four Valley Drive
Vaughan, Ontario
Canada L4K 4T9
Phone: 800-461-3007
Fax: 800-461-8989
www.assaabloydss.ca

MicroShield®

As part of their promise to provide innovative solutions to their customers, certain ASSA ABLOY Group brands offer the MicroShield® technology, registered with the EPA and FDA. MicroShield® is a silver-based antimicrobial coating designed to inhibit the growth of bacteria. MicroShield® is a registered trademark of Yale Security Inc., an ASSA ABLOY Group company.



The Agion antimicrobial is not intended as a substitute for good hygiene. Coated products must still be cleaned to ensure the surfaces will be free of destructive microbes. ASSA ABLOY makes no representations or warranties, express or implied, as to the efficacy of the Agion antimicrobial. A copy of the Agion warranty is available upon request. Agion is a registered trademark of Agion Technologies, Inc., Wakefield, MA, USA

Smooth Operation

ML2000 Series Mortise Lock

The ML2000 Series is an ANSI/BHMA Grade 1 mortise lock designed to withstand the most abusive environments. Constructed of heavy-gauge steel with unique, patented features and a full range of functions and trim, adds to its versatility and reliability to complement any application.

Applications

Offices • Schools • Hospitals



ML2000 Series

Mortise Lockset

FEATURES

- Direct drive performance for consistent torque and force during lever rotation
- Lever return is crisp and firm – eliminating lever sag
- Available in 59 mechanical and electrified functions, including vandal resistant and behavioral health options, 59 standard and Muséo Line decorative lever designs and 13 finishes
- Integrates with new or existing Corbin Russwin key systems, including patented/ high security Access 3® and Pyramid
- Integrates with access control platforms
- Occupancy indicators available
- Ten year warranty

BENEFITS

- **Innovative Design:** Optimized torsion spring design and fewer moving parts give the lock extremely smooth and consistent operations
- **Flexible:** Field reversible latchbolt makes it easy to re-hand without disassembling the lock case
- **Safe and Secure:** Withstands intrusion attempts and abuse, featuring specialized security trim and components
- **Lower Total Cost of Ownership:** Far exceeds ANSI/BHMA Grade 1 requirements ensuring durability and longevity
- **Sustainable:** Environmental product declaration (EPD) in accordance with ISO14025

Highly engineered 3 spring design for smooth, crisp, and responsive operation



Corbin Russwin Architectural Hardware
225 Episcopal Road, Berlin, CT 06037
Phone 800-543-3658
Fax 800-447-6714
www.corbinrusswin.com

ASSA ABLOY is the global leader in door opening solutions, dedicated to satisfying end-user needs for security, safety and convenience.

BIDDING REQUIREMENTS for PURCHASING

NOTICE AND INFORMATION FOR BIDDERS

Attachment C: Scope of Work and Site Logistics

Items to be furnished and delivered to:

Hutchings Psychiatric Center
Attn: Paul Brown
(315) 345-0768
520 Madison Street
Syracuse, NY 13210